

Cladding of pre-wall installation systems as a panel

LUX ELEMENTS®-TEC-VWD-...

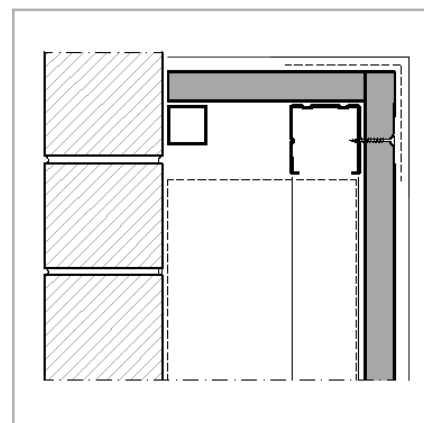
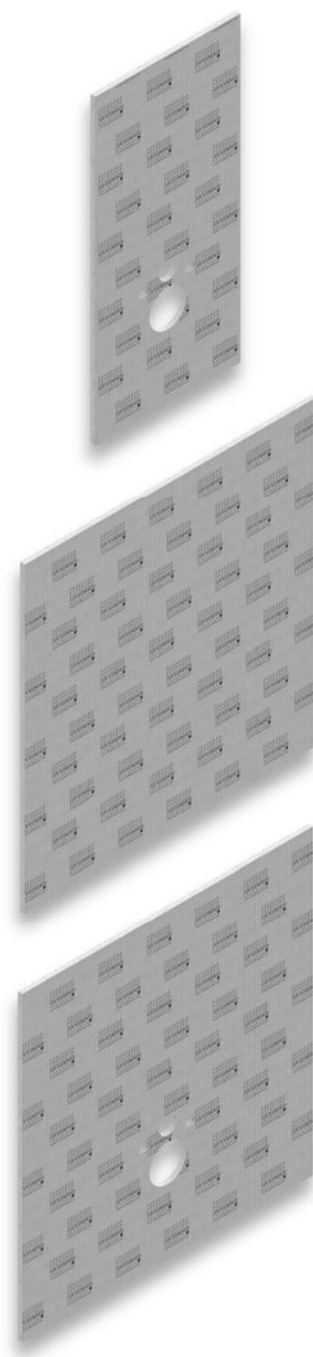

[EN] – Instructions for assembly

TOOLS/MATERIALS REQUIRED



LUX ELEMENTS®-COL-MK
PLEASE NOTE:
 Eye and face protection

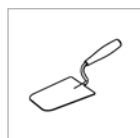

LUX ELEMENTS®-COL-AK
PLEASE NOTE:
 Wear protective gloves/clothing,
 eye and face protection

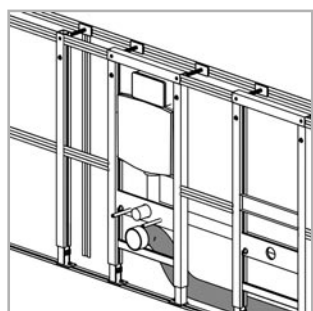
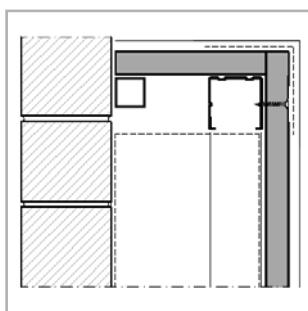

Please note: The wall-mounted construction forms the sub-construction. When planking with wall-mounted system elements, the information issued by the respective manufacturer must be taken into consideration.

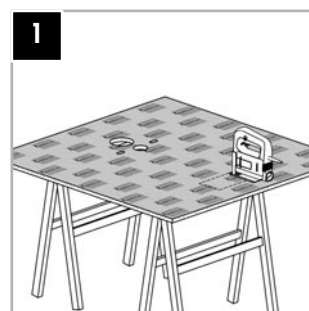

The element including the notch for the subsequent assembly of the push plate are cut to size.

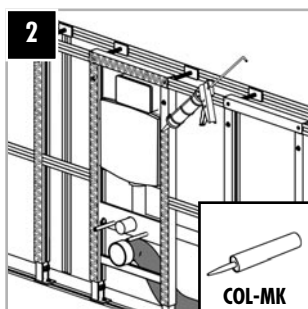

Apply COL-MK on both the support structure as well as on the element. We recommend a snake-shaped application of cartridge adhesives.

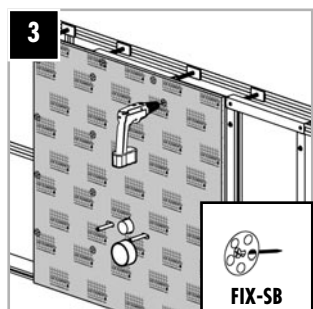

Screw with the fastening kit FIX-SB 45S35. Observe the wall-mounted element manufacturer's recommendation as to spacing.

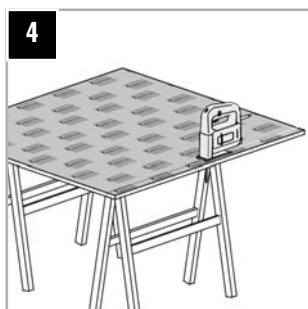

TEC-VWD-E panels are suitable for the adjacent covering, as well as for the upper covering. After cutting to size, these will be ...

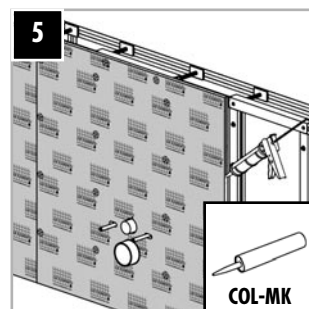

... glued together and glued together with the support construction. Apply the adhesive to the plate edges as an uninterrupted strand.

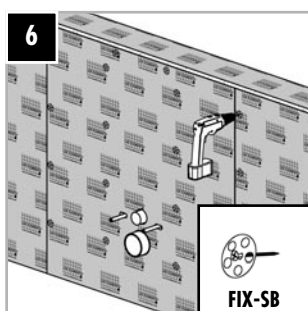

After bonding with the construction and the wall screw tight using FIX-SB 45S35.

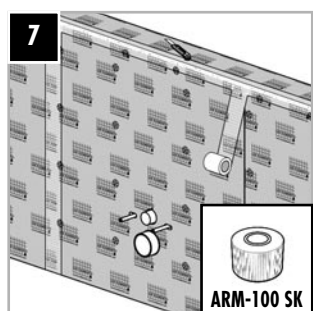

Reinforce all element joints and transitions with glass fibre reinforcement strips ARM-100 SK and ...

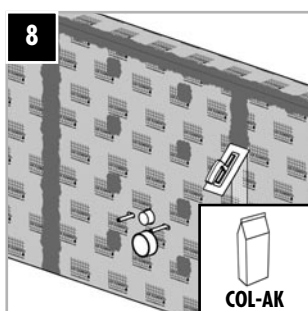

... finally level out the element joints and the heads of the mounting elements with COL-AK.

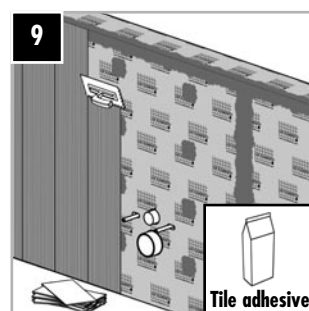

The surface is now ready for tiling. Further requirements (e.g. sealing) must be taken into consideration in accordance with national directives.



Installation videos



Mobile website

We reserve the right to make technical changes. Our products vary regarding the scope of delivery. Please refer to the information, for example, in the product description, the order confirmation or on the packaging.

For further information ... please refer to our documents. Data sheets, test certificates and processing instructions can be downloaded from www.luxelements.com

EN-11/2021 · PROS3205