

Product Description

LUX ELEMENTS®-TUB-LINE BOL are special shower base elements for the substitution of bath tubs. The shower base elements consist of a hard foam core of expanded polystyrene with special mortar coating on both sides reinforced with glass fibre fabric and factory-made sealing on the upper side with integrated and sealed floor drain support frame.

System components

- **LUX ELEMENTS®-DRY-DB** is a sealing tape fleece backed on both sides, which is ideally suited for wall/floor connections and for the formation of wall corners.
 - width: 100 mm
 - thickness: approx. 0,6 mm
- **LUX ELEMENTS®-DRY-DBIE/AE** are deep drawn interior or exterior corners fleece backed on both sides, which are ideally suited for fast and secure formation of corner seals (suitable for LUX ELEMENTS®-DRY-DB).
- **LUX ELEMENTS®-DRY-ASK** is a single-component, water-impermeable, crack-bridging and flexible sealing compound.
- **LUX ELEMENTS®-COL-FLEX** is a flexible cement powder adhesive suitable for the thin-bed adhesion in accordance with DIN 18157 Part 1 of:
 - of ceramic tiles, panels and mosaic
 - fine stoneware
 - discolouration-resistant natural stone panels
 - ceramic coatings in pools

LUX ELEMENTS®-COL-FLEX meets the C2TE-S1 requirements according to EN 12004 and EN 12002.

Applications

LUX ELEMENTS®-TUB-LINE BOL shower bases are provided with ceramic covering and can be used wherever building regulations stipulate barrier-free construction e.g. in homes for the elderly, disabled person's dwellings etc. and of course wherever the comfort and aesthetics of modern building methods are desirable. Thus our shower base $\geq 120 \times 120$ cm and $\geq 150 \times 150$ cm are certified according to the appropriate standards.

The LUX ELEMENTS®-TUB-LINE BOL products are equivalent to the bonded panel-type sealing materials described in DIN 18534 Part 6. They are usable for the water action class W2-I as AIV-P. We would ask that you consult our Technical Department before using them in the water action class W3-I.

LUX ELEMENTS®-TUB-LINE BOL shower bases fulfil the requirements for the waterproofing of buildings in conjunction with tiles and pavings according to the building rules list A, part 2 number 2.50. The range of application refers to moisture exposure class A2 for directly exposed floor areas in rooms in which service or cleaning water is frequently or continuously used, such as e.g. transitional areas in swimming pools and shower units (public and private).

General Building Authority Approved Test Certificate No. P-AB/20802/05-2008 issued by Kiwa MPA Baustest GmbH Niederlassung tBU Greven.

Furthermore, the LUX ELEMENTS®-TUB-LINE BOL shower base elements are system components for the LUX ELEMENTS®-WATERTIGHT SOLUTION sealing system and fulfil the directive for the European Technical Approval for 'Watertight covering kits for wet room floors and or walls - Part 3: Kits based inherently on watertight boards', ETAG 022-3.



Herstellung einer Abdichtung im Verband mit Fliesen- und Plattenbelägen unter Einsatz von LUX ELEMENTS®-TUB als Abdichtungssystem gemäß Bauregelleiste A Teil 2, Hfd. Nr. 2.50, Baumprüfungsstelle A2



ETA-13/0238
 LUX ELEMENTS®
 WATER TIGHT SOLUTION
 COMPONENT 3.2/8
 www.luxelements.com
 0799-CFD-130 - Nr. LEWS2013

Substrate

- firm, load-bearing, clean and vibration-free mineral floors

Recommended use

LUX ELEMENTS®-TUB-LINE BOL shower base elements consist of a slope area from 1200 x 900 mm respectively 750 mm and a 600 mm wide area without a slope. The LUX ELEMENTS®-TUB-LINE BOL shower base elements can be shortened as required in areas without slope. In all cases, a 50 mm wide margin must remain, measured from the edge of the installation frame in areas with slope. We would like to point out that LUX ELEMENTS®-TUB-LINE BOL shower bases which are not shortened all round with the same measurements then have a different external thickness due to the built-in slope, thus leading to an offset to the adjacent floor.

Note also the enclosed assembly instructions: 'LUX ELEMENTS®-TUB/TUB-LINE Instructions for assembly'.

Covering materials

The LUX ELEMENTS®-TUB-LINE BOL shower bases were specially developed for coverings with ceramic covering materials. The ceramic covering takes on the function of the load distribution layer. The loads that can be anticipated in use are to be specified by the specialist planner. The covering must be selected according to the specified load.

Mosaic $\geq 20 \times 20 \times 4$ mm with front-mount adhesive film can be used as the lining for both low exposures and heavier loads (e.g. wheelchair use of up to 200 kg) so long as a reaction resin is used for gluing and joining. If the size of the tiles is $\geq 50 \times 50$ mm, tile adhesive of quality grade C2 can be used for gluing and a cementitious grout material for joining. Please take note of our General Building Authority Approved Test Certificate No. P-AB/20802/05-2008 from tBU GmbH and/or our European Technical Approval according to ETAG 022-3 when covering our shower base elements with surface materials. Ensure that the tiles/mosaic pieces have a sufficient breaking strength. The shower base element should not be subjected to loads greater than 0.1 N/mm^2 .

LUX ELEMENTS®-TUB-LINE BOL shower bases should be protected between assembly and tiling processes from damage to the sealing. Even if subjected to incorrect use, e.g. stepladders for repair work, make sure load is evenly distributed.

Technical Specifications

- Overall height of shower base element 45 mm [*]
- Floor drain frame: ABS plastic
- Grate: stainless steel 1.4301, load class K3 (up to max. 300 kg)
- Frame: stainless steel 1.4301
- Integrated slope from 45 mm to 30 mm [*]. The design of descending gradients and directions belongs to planning services. Special designs up to a maximum thickness of 65 mm are possible apart from the descending gradients stated here.
- Compressive strength of 0.1 N/mm^2
- * standard (other thicknesses possible)

■ Secondary drainage

All LUX ELEMENTS®-TUB-LINE shower base elements are equipped with a second drainage level.

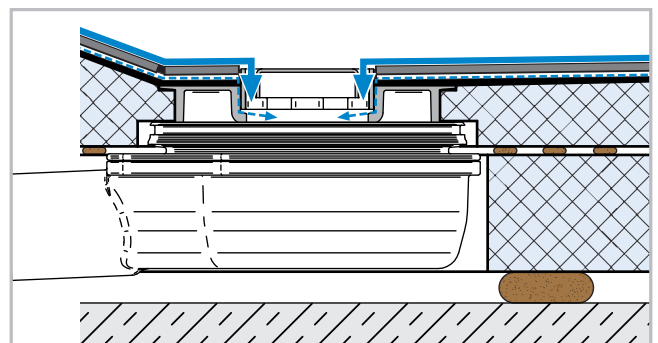

■ **LUX ELEMENTS®-TUB-LINE BA-S** (vertical shower drain)



- Floor drain support DN 50, vertical, without odour trap
- Core hole \varnothing 145–160 mm
- Sealing water height 22 mm in removable odour trap of the floor channel drain (optional 50 mm)

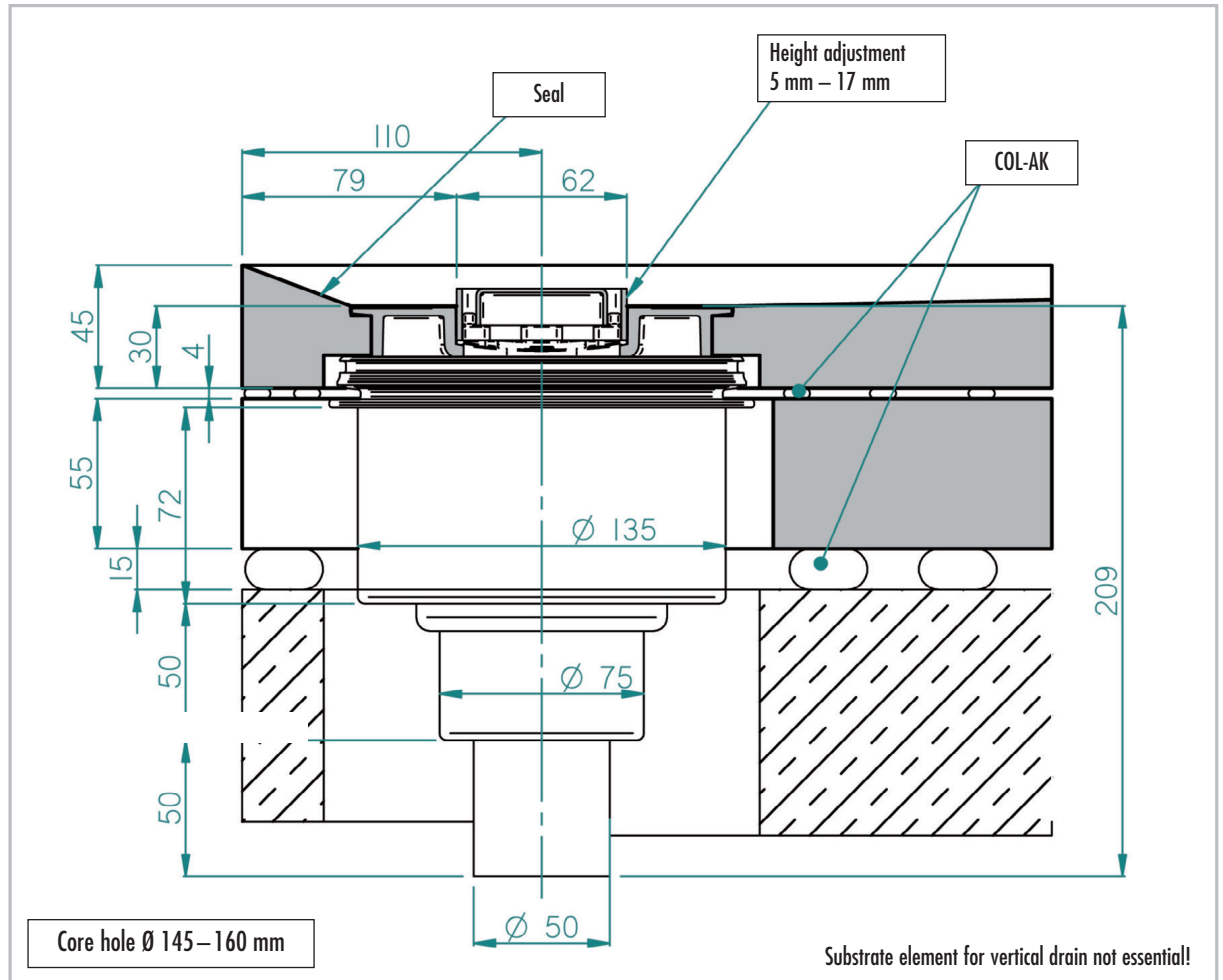

	Standard odour trap DN 50 vertical – Drain performance [l/s] in accordance with DIN EN 1253	Covering thickness of shower base (tile + adhesive)
TUB-LINE BA-S	0.8	5 – 17 mm

The installation of a hair trap (TUB-LINE-BAZ HS) can reduce the drainage capacity by up to 0.2 l/s.

The installation of the Multistop (TUB-LINE-BAZ STOP) can increase the drainage capacity by up to 0.2 l/s.

LUX ELEMENTS®-TUB-LINE BOL Shower base elements

Reviewed on: 01/2018
 Replace DS from: 11/2015

■ **LUX ELEMENTS®-TUB-LINE BA-W** (horizontal shower drain)



- Floor drain support DN 50, horizontal, without odour trap
- Sealing water height 22 mm in removable odour trap of the floor channel drain

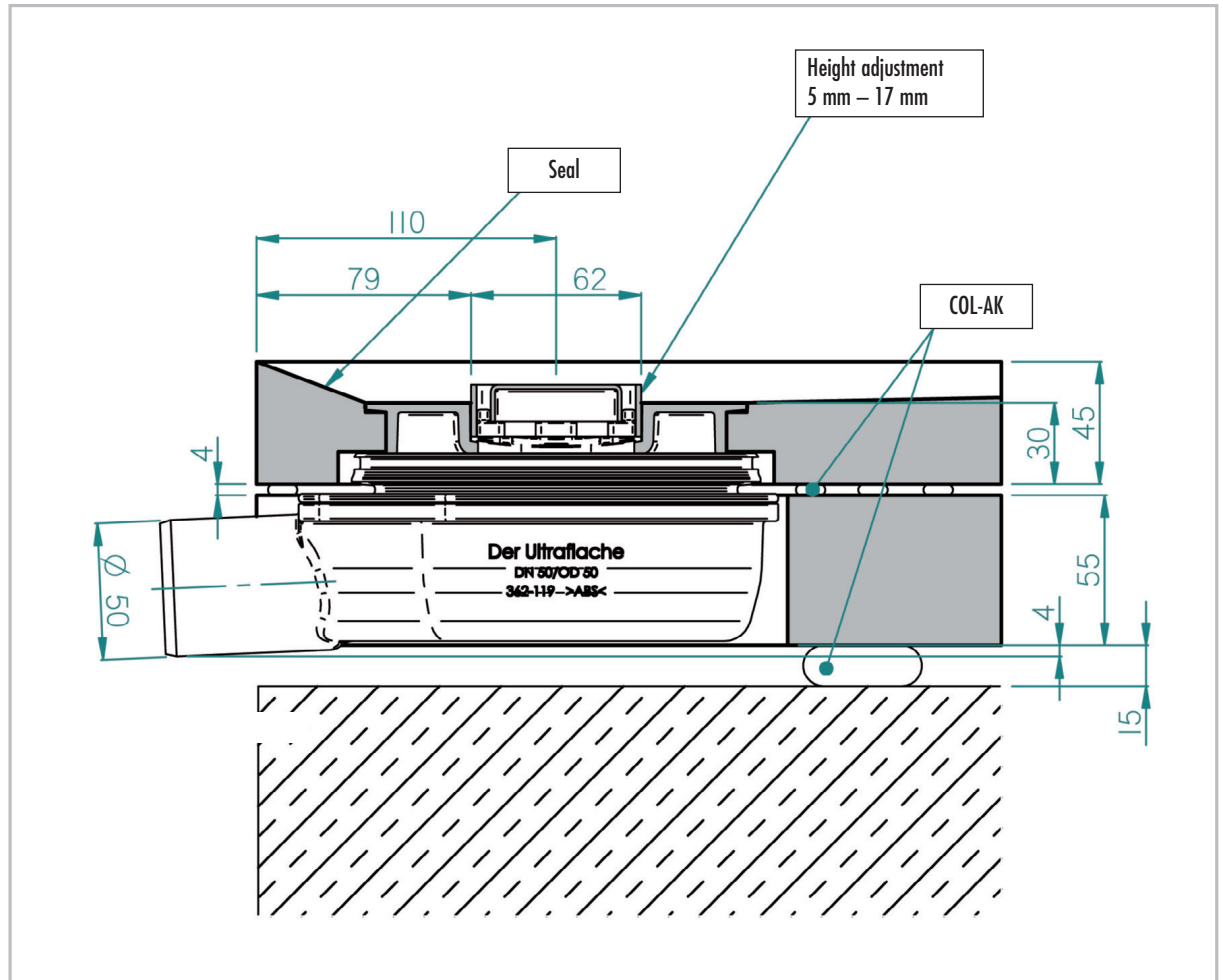

	Standard odour trap DN 50 horizontal – Drain performance [l/s] in accordance with DIN EN 1253	Covering thickness of shower base (tile + adhesive)
TUB-LINE BA-W	0.8	5 – 17 mm

The installation of a hair trap (TUB-LINE-BAZ HS) can reduce the drainage capacity by up to 0.2 l/s.

The installation of the Multistop (TUB-LINE-BAZ STOP) can increase the drainage capacity by up to 0.2 l/s.

■ **In general**

Please note that with flush with the floor shower bases, in the case of

- a low slope
- rough ceramics
- the lack of a shower enclosure
- unfavourable shower head placement
- high water pressure or high quantity of water (e.g. in the case of flood showers)

water can run out of the shower area or accumulate. Please refer to our planning aids and FAQ's for the planning of shower bases on our website (www.luxelements.com).

■ **Accessories**

LUX ELEMENTS®-TUB-LINE-BAZ STOP is a retrofittable odour, foam and vermin barrier, which can be installed instead of a standard siphon trap.



TUB-LINE-BAZ STOP



LUX ELEMENTS®-TUB-LINE-BAZ HS is a removable PP plastic hair trap.



TUB-LINE-BAZ HS

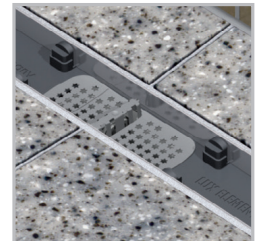

LUX ELEMENTS®-TUB-BAZ DN 50/40 is a DN 50 to DN 40 reducer with lip seal.



TUB-BAZ DN 50/40

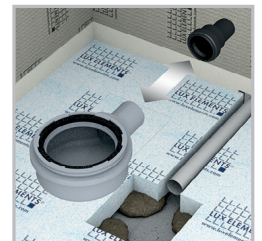

LUX ELEMENTS®-TUB-BAZ BST is an adapter from DN 50 to British Standard, made of PVC.



TUB-BAZ BST



LUX ELEMENTS®-TUB-BAZ HTK replaces six traditional HT bends from 0 to 87 degrees. (see data sheet LUX ELEMENTS®-TUB-BAZ HTK)

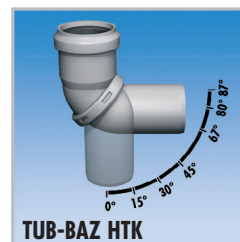

TUB-BAZ HTK

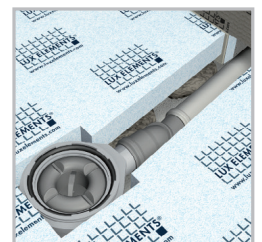

LUX ELEMENTS®-TUB-LINE BOL Shower base elements

Reviewed on: 01/2018
 Replace DS from: 11/2015

LUX ELEMENTS®-TUB-LINE BA-S FIRE STOP consists of a DN 50 TUB-LINE BA-S floor drain support for core drill hole Ø 160 mm, vertical with odour trap (sealing water height 50 mm), including TUB-BAZ-VER extension piece and fire protection insert for pipe bushing.

The Fire-Kit pipe bushing system as per approval number Z-19.17-1719 prevents the transmission of fire and smoke for a fire resistance period of 120 minutes or 90 minutes respectively (depending on the ceiling) according to DIN 4102-2, taking into account the requirements specified in the approval.

LUX ELEMENTS®-TUB-BAZ DGD is a conduit seal with fire protection in connection with the TUB-LINE BA-S FIRE STOP for core drill hole Ø 160 mm, which, in accordance with approval number Z-19.17-1719, prevents the transmission of fire and smoke for a fire resistance period of 120 minutes or 90 minutes respectively (depending on the ceiling) according to DIN 4102-2, taking into account the requirements specified in the approval.

LUX ELEMENTS®-TUB-BAZ VER is an extension piece for the TUB-BA-S, TUB-BA-S 100 and TUB-LINE BA-S.

LUX ELEMENTS®-TUB-TSM, impact sound insulating mat, 1250 x 1250 x 6 mm. (see data sheet LUX ELEMENTS®-TUB-TSM)



TUB-LINE BA-S FIRE STOP



TUB-BAZ DGD



TUB-BAZ VER

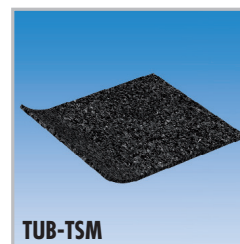

TUB-TSM

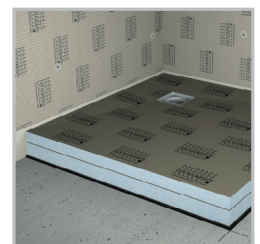

The relevant recommendations and guidelines, as well as DIN regulations, European standards and safety datasheets are to be observed. The recognised architectural and technical rules apply. We accept liability for the perfect quality of our products. Our processing recommendations are based upon trials and practical experience; they can, however, be no more than general instructions without assurance as to their quality, since we have no influence on the site conditions, on the execution of the work and the processing. With the issuing of this product datasheet previous versions cease to be valid.