A close-up photograph of a person's feet standing on a wetroom floor. The floor is made of large, light-colored tiles with a central rectangular drain. The person's feet are wet, and water is visible on the tiles. The drain is a dark, rectangular metal grate with a textured surface. The background is a blurred wall, suggesting a shower or wetroom environment.

PROFESSIONAL WETROOMS

from LUX ELEMENTS





'Quality made in Germany'

Professional wetrooms from LUX ELEMENTS proven worldwide

- **Decades of experience**
in processing hard foam panels and shower trays
- **Modern flexible production methods**
in our own production plants
- **Individual production**
of your components as individual or series products
- **High level of technical expertise**
owing to our own development department
- **International team**
with multilingual contacts
- **Professional advice**
by experienced employees
- **Quality control from the start**
through entirely in-house production
- **Certified quality management**



LUX ELEMENTS is a German based manufacturing company specialising in wetroom constructions.

We have been supplying the tiling industry for over 33 years and recognise how important each individual project is.

Whether your project is domestic or commercial choosing LUX ELEMENTS guarantees one thing "Wetrooms in safe hands".





NOTE:

For further information about the proven material advantages please see:

www.the-original-can-do.com





So why choose LUX ELEMENTS for your wetroom solution?

We have been working in the tiling industry for over 3 decades and recognise the problems that can occur when waterproofing fails.

We have developed high quality waterproof flooring and walling systems to deal with the demands of both old and modern buildings. Whether the floor is solid or timber LUX ELEMENTS will ensure peace of mind and a longer life for the tiles.

Invest in a secure wetroom solution,
invest in LUX ELEMENTS!





Double Security

with second drainage level

Tiles and grout are not watertight, have you ever wondered what happens to the water when it passes through the grout and tiles and on to the waterproof layer?

The truth is most people don't think of this but it can be a major problem. LUX ELEMENTS is one of the few companies who provide a solution. Our secondary drainage channel will evacuate the water even when it gets under your tiles. This will ensure tiles stay firmly fixed to the tray and adhesives are not affected sitting in water. It will also keep your grout in better condition and further the life of your wetroom floor.

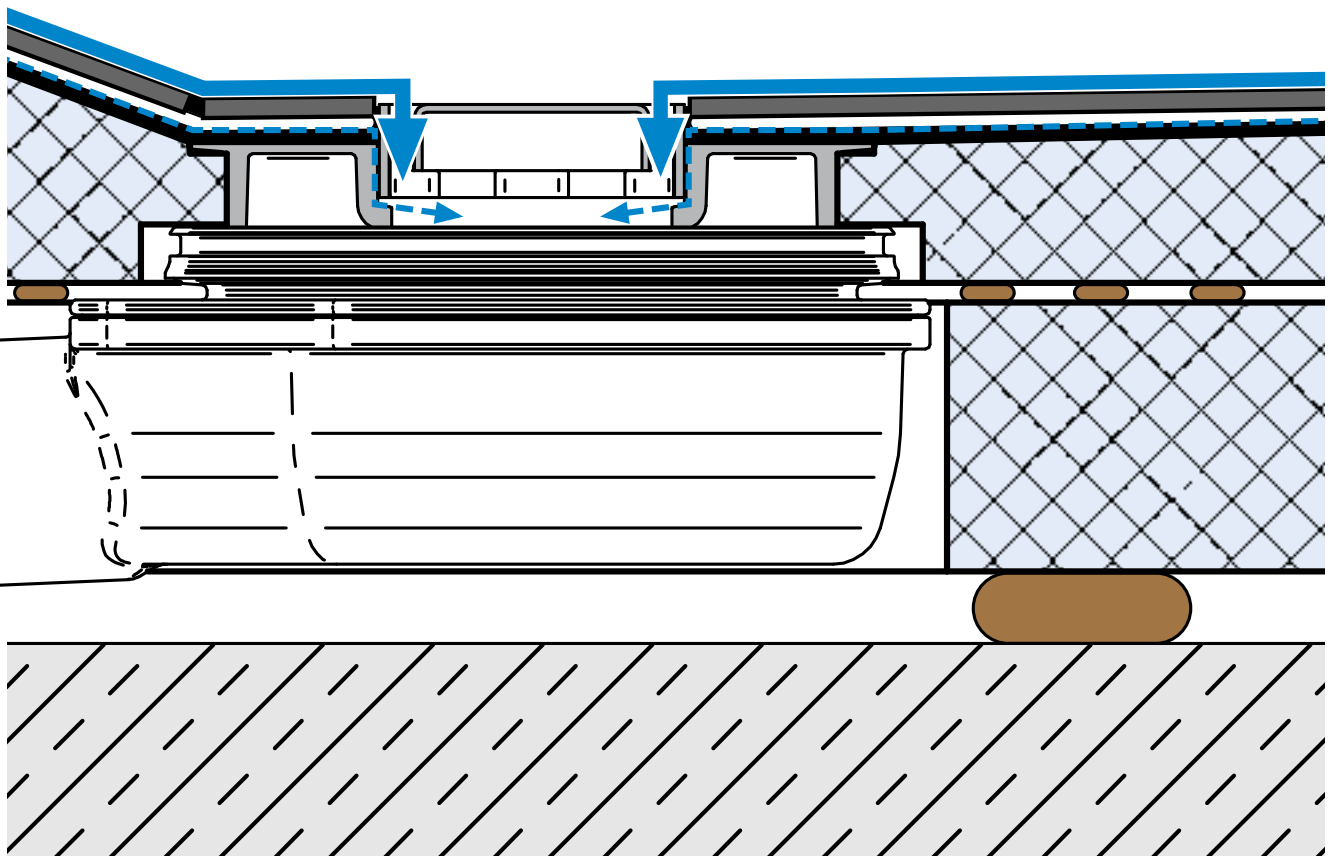





LUX ELEMENTS

Wetroom trays

Simple to install yet technically inspiring

LUX ELEMENTS® tileable shower trays offer total waterproofing for timber and concrete floors. They are easy to install, look great and offer the highest drainage performance available on the market today.

They can be installed level, as a small step up or a higher step up depending on your drainage requirements.

- **Waterproofed in our factory**
to the highest European (ETA) standards.
- **Unique secondary drainage**
to clear water from beneath the tiles.
- **Supplied with a substantial gradient**
to ensure excellent drainage.
- **High performance drainage**
with a variety of finishes available including linear.
- **Simple installation**
to minimise time on site.





Professional Wetrooms

Level access shower trays

30 mm level access shower trays are perfect for timber substrates when the whole floor needs to be level. They can be trimmed down or increased in size with matching 30 mm board.









Specifications and prices

Level access shower trays

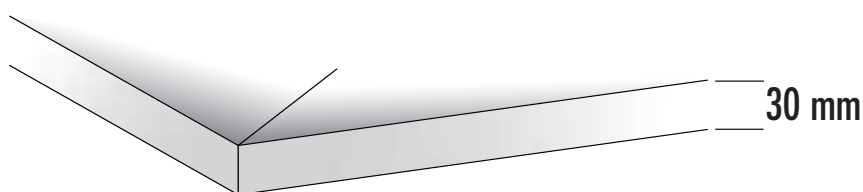

NOTE:
The components you need to install your shower tray are assembled by a certain principle. Please see page 51.

A Level access shower trays – 30 mm – point drainage

Hard foam shower base elements, square or rectangular, with installed and sealed-in floor drain fitting frame 135 x 135 mm in the corner or in the center.

TUB-HEQ TUB-HMQ TUB-HER TUB-HMR	Product specifications					Suggested Installation Kit
	Article-number	Article-name	Article-description	Nominal formats/dimensions length x width x height	Unit	
	LTUBE17001	TUB-HEQ 900	square, corner drain	900 x 900 x 15/30 mm	Piece	TUB-KIT UNI
	LTUBE17002	TUB-HEQ 1200	square, corner drain	1200 x 1200 x 15/30 mm	Piece	TUB-KIT UNI GK
	LTUBE17101	TUB-HMQ 900	square, centre drain	900 x 900 x 15/30 mm	Piece	TUB-KIT UNI
	LTUBE17103	TUB-HMQ 1000	square, centre drain	1000 x 1000 x 15/30 mm	Piece	TUB-KIT UNI GK
	LTUBE17102	TUB-HMQ 1200	square, centre drain,	1200 x 1200 x 15/30 mm	Piece	TUB-KIT UNI GK
	LTUBE17011	TUB-HER 1200/900	rectangular, corner drain	1200 x 900 x 15/30 mm	Piece	TUB-KIT UNI GK
	LTUBE17013	TUB-HER 1400/900	rectangular, corner drain	1400 x 900 x 15/30 mm	Piece	TUB-KIT UNI GK
	LTUBE17012	TUB-HER 1600/900	rectangular, corner drain	1600 x 900 x 15/30 mm	Piece	TUB-KIT UNI GK
	LTUBE17111	TUB-HMR 1200/900	rectangular, centre drain	1200 x 900 x 15/30 mm	Piece	TUB-KIT UNI GK
	LTUBE17112	TUB-HMR 1600/900	rectangular, centre drain	1600 x 900 x 15/30 mm	Piece	TUB-KIT UNI GK

A Walk in showers or bath tub replacement showers – 30 mm – point drainage

Hard foam shower base element, rectangular, with installed and sealed-in floor drain fitting frame 135 x 135 mm. Drain in the slope area in the centre.

TUB-H BOL 1800/900	Product specifications					Suggested Installation Kit
	Article-number	Article-name	Article-description	Nominal formats/dimensions length x width x height	Unit	
	LTUBE17018	TUB-H BOL 1800/900	can be cut to length to minimum 900 x 1200 mm, slope area from 900 x 1200 mm	1800 x 900 x 15/30 mm	Piece	TUB-KIT UNI GK



B Floor drain support – point drainage

Floor drain support DN 50, with odour trap, incl. 130 x 130 mm grate fitting frame made of ABS and 120 x 120 mm standard stainless steel grate; universal height adjustment to suit tile thickness.

		Product specifications			
		Article-number	Article-name	Article-description	Unit
TUB-BAW-S	LTUBE1184	TUB-BAW-S	horizontal	Set	
TUB-BAS-S	LTUBE1180	TUB-BAS-S	vertical	Set	

C DN 50 to British standard adaptor

All LUX ELEMENTS® drains require a TUB-BAZ BST adaptor or similar.

		Product specifications			
		Article-number	Article-name	Article-description	Unit
TUB-BAZ BST	LTUBE1190	TUB-BAZ BST	made of PVC	Piece	

D Shower tray installation Kit

LUX ELEMENTS offers installation Kits complete with adhesive, tape sealer, waterproofing tape and two internal corners.

		Product specifications			
		Article-number	Article-name	Article-description	Unit
TUB-KIT UNI	LTUBE1090	TUB-KIT UNI	5 kg COL-AK, 3,5 kg DRY-ASK, 10 m DRY-DB, 2 pieces DRY-DBIE (inner corners)	Kit	
TUB-KIT UNI GK	LTUBE1098	TUB-KIT UNI GK	3 x 5 kg COL-AK, 3,5 kg DRY-ASK, 10 m DRY-DB, 2 pieces DRY-DBIE (inner corners)	Kit	
TUB-KIT UNI GG	LTUBE1099	TUB-KIT UNI GG	5 x 5 kg COL-AK, 3,5 kg DRY-ASK, 10 m DRY-DB, 2 pieces DRY-DBIE (inner corners)	Kit	



Specifications and prices

Level access shower trays

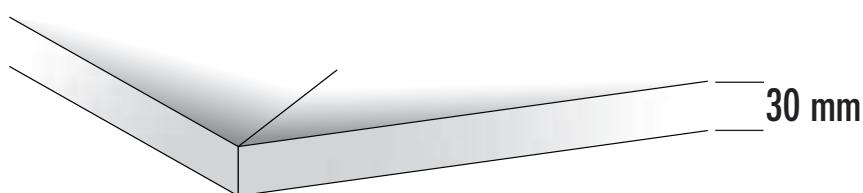



NOTE:

The components you need to install your shower tray are assembled by a certain principle. Please see page 51.

A Level access shower trays – 30 mm – linear drainage

Hard foam shower base elements with 4-sided gradient, square or rectangular, with integrated and sealed floor channel drain **70 x 750 mm** or **70 x 850 mm** on shorter side, cover rail brushed stainless steel, with odour trap, height adjustable with height adapter from 5–17 mm.

Product specifications	Product specifications						Suggested Installation Kit
	Article-number	Article-name	Article-description	Nominal formats/dimensions length x width x height	Unit		
 TUB-LINE HQ4	LTUBE96001	TUB-LINE HQ4 900	square, 750 mm channel drain	900 x 900 x 20/30 mm	Piece		TUB-KIT UNI
	LTUBE96003	TUB-LINE HQ4 1000	square, 850 mm channel drain	1000 x 1000 x 20/30 mm	Piece		TUB-KIT UNI
 TUB-LINE HR4	LTUBE96004	TUB-LINE HQ4 1200	square, 850 mm channel drain	1200 x 1200 x 20/30 mm	Piece		TUB-KIT UNI GK
	LTUBE96002	TUB-LINE HR4 1200/900	rectangular, 750 mm channel drain	1200 x 900 x 20/30 mm	Piece		TUB-KIT UNI GK
	LTUBE96005	TUB-LINE HR4 1400/900	rectangular, 750 mm channel drain	1400 x 900 x 20/30 mm	Piece		TUB-KIT UNI GK

A Level access shower trays – 30 mm – linear drainage

Hard foam shower base elements with 4-sided gradient, rectangular, with integrated and sealed floor channel drain **70 x 650 mm** on shorter side, cover rail brushed stainless steel, with odour trap, height adjustable with height adapter from 5–17 mm.

Product specifications	Product specifications						Suggested Installation Kit
	Article-number	Article-name	Article-description	Nominal formats/dimensions length x width x height	Unit		
 TUB-LINE PLUS HR4	LTUBEPLUS110101	TUB-LINE PLUS HR4 1000/800	rectangular, 650 mm channel drain	1000 x 800 x 20/30 mm	Piece		TUB-KIT UNI
	LTUBEPLUS110102	TUB-LINE PLUS HR4 1400/800	rectangular, 650 mm channel drain	1400 x 800 x 20/30 mm	Piece		TUB-KIT UNI GK

A Walk in showers or bath tub replacement showers – 30 mm – linear drainage

Hard foam channel support element with 4-sided gradient, integrated and sealed floor channel drain **70 x 750 mm** on shorter side, cover rail made from stainless steel, with odour trap, height adjustable with height adapter from 5–17 mm. Slope area from 900 x 1200 mm.



Product specifications						Suggested Installation Kit
Article-number	Article-name	Article-description	Nominal formats/dimensions length x width x height	Unit		
LTUBE97101	TUB-LINE H BOL 1800/900	can be cut to length to min. 900 x 1000 mm, slope area from 900 x 1200 mm	1800 x 900 x 20/30 mm	Piece		TUB-KIT UNI GK

B Floor drain support – linear drainage

Floor drain support DN 50, without odour trap.

Product specifications					
Article-number	Article-name	Article-description	Unit		
LTUBE1112	TUB-LINE BA-W	horizontal	Piece		
LTUBE1113	TUB-LINE BA-S	vertical	Piece		

C DN 50 to British standard adaptor

All LUX ELEMENTS® drains require a TUB-BAZ BST adaptor or similar.

Product specifications					
Article-number	Article-name	Article-description	Unit		
LTUBE1190	TUB-BAZ BST	made of PVC	Piece		

D Shower tray installation Kit

LUX ELEMENTS offers installation Kits complete with adhesive, tape sealer, waterproofing tape and two internal corners.

Product specifications					
Article-number	Article-name	Article-description	Unit		
LTUBE1090	TUB-KIT UNI	5 kg COL-AK, 3,5 kg DRY-ASK, 10 m DRY-DB, 2 pieces DRY-DBIE (inner corners)	Kit		
LTUBE1098	TUB-KIT UNI GK	3 x 5 kg COL-AK, 3,5 kg DRY-ASK, 10 m DRY-DB, 2 pieces DRY-DBIE (inner corners)	Kit		
LTUBE1099	TUB-KIT UNI GG	5 x 5 kg COL-AK, 3,5 kg DRY-ASK, 10 m DRY-DB, 2 pieces DRY-DBIE (inner corners)	Kit		





Professional Wetrooms

Low profile shower trays

45 mm low profile shower trays are ideal for level access installations on concrete floors or as a small step up tray. They can be trimmed down and are ideal for awkward or unusual size spaces.



Specifications and prices

Low profile shower trays

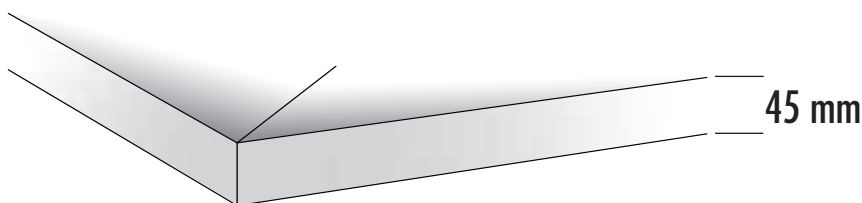

NOTE:

The components you need to install your shower tray are assembled by a certain principle. Please see page 51.

A Low profile shower trays – 45 mm – point drainage

Hard foam shower base elements, square or rectangular, with installed and sealed-in floor drain fitting frame 135 x 135 mm in the corner or in the centre.

		Product specifications					Suggested Installation Kit
		Article-number	Article-name	Article-description	Nominal formats/dimensions length x width x height	Unit	
	TUB-EQ	LTUBE10001	TUB-EQ 900	square, corner drain	900 x 900 x 30/45 mm	Piece	TUB-KIT UNI
		LTUBE10002	TUB-EQ 1000	square, corner drain	1000 x 1000 x 30/45 mm	Piece	TUB-KIT UNI
		LTUBE10003	TUB-EQ 1200	square, corner drain	1200 x 1200 x 30/45 mm	Piece	TUB-KIT UNI GK
		LTUBE10101	TUB-MQ 900	square, centre drain	900 x 900 x 30/45 mm	Piece	TUB-KIT UNI
		LTUBE10102	TUB-MQ 1000	square, centre drain	1000 x 1000 x 30/45 mm	Piece	TUB-KIT UNI
		LTUBE10103	TUB-MQ 1200	square, centre drain	1200 x 1200 x 30/45 mm	Piece	TUB-KIT UNI GK
		LTUBE10104	TUB-MQ 1500	square, centre drain	1500 x 1500 x 30/45 mm	Piece	TUB-KIT UNI GK
		LTUBE10601	TUB-ER 1200/900	rectangular, off centre drain	1200 x 900 x 30/45 mm	Piece	TUB-KIT UNI GK
		LTUBE10602	TUB-ER 1200/1000	rectangular, off centre drain	1200 x 1000 x 30/45 mm	Piece	TUB-KIT UNI GK
		LTUBE10603	TUB-ER 1400/900	rectangular, off centre drain	1400 x 900 x 30/45 mm	Piece	TUB-KIT UNI GK
		LTUBE10605	TUB-ER 1600/900	rectangular, off centre drain	1600 x 900 x 30/45 mm	Piece	TUB-KIT UNI GK
		LTUBE10701	TUB-MR 1000/800	rectangular, centre drain	1000 x 800 x 30/45 mm	Piece	TUB-KIT UNI GK
		LTUBE10702	TUB-MR 1200/900	rectangular, centre drain	1200 x 900 x 30/45 mm	Piece	TUB-KIT UNI GK
		LTUBE10706	TUB-MR 1600/900	rectangular, centre drain	1600 x 900 x 30/45 mm	Piece	TUB-KIT UNI GK

A Walk in showers or bath tub replacement showers – 45 mm – point drainage

Hard foam shower base elements, rectangular, with installed and sealed-in floor drain fitting frame 135 x 135 mm, for mineral substrates and timber sub-constructions, flush with the floor or with a sufficient installation height for drain fittings and pipes.

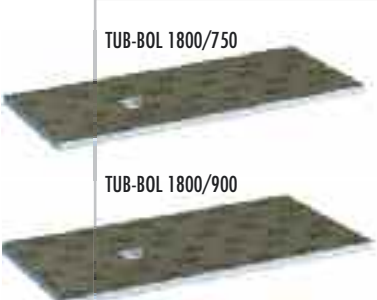
	Product specifications					Suggested Installation Kit
	Article-number	Article-name	Article-description	Nominal formats/dimensions length x width x height	Unit	
	LTUBE18016	TUB-BOL 1800/750	can be cut to length to minimum 750 x 1200 mm, slope area from 750 x 1200 mm, drain in the slope area in the centre	1800 x 750 x 30/45 mm	Piece	
LTUBE18018	TUB-BOL 1800/900	can be cut to length to minimum 900 x 1200 mm, slope area from 900 x 1200 mm, drain in the slope area in the centre	1800 x 900 x 30/45 mm	Piece	TUB-KIT UNI GK	

B Floor drain support – point drainage

Floor drain support DN 50, with odour trap, incl. 130 x 130 mm grate fitting frame made of ABS and 120 x 120 mm standard stainless steel grate; universal height adjustment to suit tile thickness.

	Product specifications				
	Article-number	Article-name	Article-description	Unit	
	LTUBE1184	TUB-BAW-S	horizontal	Set	
LTUBE1180	TUB-BAS-S	vertical	Set		

C DN 50 to British standard adaptor

All LUX ELEMENTS® drains require a TUB-BAZ BST adaptor or similar.

	Product specifications				
	Article-number	Article-name	Article-description	Unit	
LTUBE1190	TUB-BAZ BST	made of PVC	Piece		

D Shower tray installation Kit

LUX ELEMENTS offers installation Kits complete with adhesive, tape sealer, waterproofing tape and two internal corners.

	Product specifications				
	Article-number	Article-name	Article-description	Unit	
	LTUBE1090	TUB-KIT UNI	5 kg COL-AK, 3,5 kg DRY-ASK, 10 m DRY-DB, 2 pieces DRY-DBIE (inner corners)	Kit	
	LTUBE1098	TUB-KIT UNI GK	3 x 5 kg COL-AK, 3,5 kg DRY-ASK, 10 m DRY-DB, 2 pieces DRY-DBIE (inner corners)	Kit	
LTUBE1099	TUB-KIT UNI GG	5 x 5 kg COL-AK, 3,5 kg DRY-ASK, 10 m DRY-DB, 2 pieces DRY-DBIE (inner corners)	Kit		



Specifications and prices

Low profile shower trays

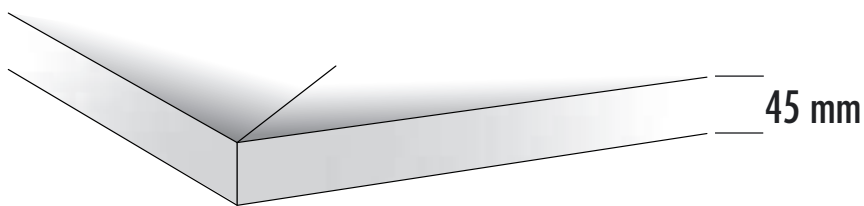

NOTE:

The components you need to install your shower tray are assembled by a certain principle. Please see page 51.

A Low profile shower trays – 45 mm – linear drainage

Hard foam shower base elements with 4-sided gradient, square or rectangular, with integrated and sealed floor channel drain **70 x 750 mm** or **70 x 850 mm** on shorter side. Cover rail brushed stainless steel, with odour trap, height adjustable with height adapter from 5–17 mm.

		Product specifications					
	TUB-LINE Q4	Article-number	Article-name	Article-description	Nominal formats/dimensions length x width x height	Unit	Suggested Installation Kit
		LTUBE94001	TUB-LINE Q4 900	square, 70 x 750 mm channel drain	900 x 900 x 30/45 mm	Piece	TUB-KIT UNI
		LTUBE94017	TUB-LINE Q4 1000	square, 70 x 850 mm channel drain	1000 x 1000 x 30/45 mm	Piece	TUB-KIT UNI
		LTUBE94019	TUB-LINE Q4 1200	square, 70 x 850 mm channel drain	1200 x 1200 x 30/45 mm	Piece	TUB-KIT UNI GK
	TUB-LINE R4	LTUBE94003	TUB-LINE R4 1200/900	rectangular, 70 x 750 mm channel drain	1200 x 900 x 30/45 mm	Piece	TUB-KIT UNI GK
		LTUBE94005	TUB-LINE R4 1400/900	rectangular, 70 x 750 mm channel drain	1400 x 900 x 30/45 mm	Piece	TUB-KIT UNI GK
		LTUBE94007	TUB-LINE R4 1600/900	rectangular, 70 x 750 mm channel drain	1600 x 900 x 30/45 mm	Piece	TUB-KIT UNI GK
		LTUBE94021	TUB-LINE R4 1200/1000	rectangular, 70 x 850 mm channel drain	1200 x 1000 x 30/45 mm	Piece	TUB-KIT UNI GK

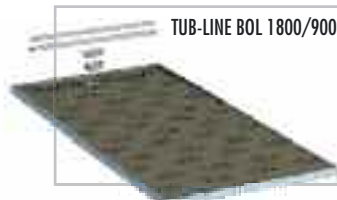

A Walk in showers or bath tub replacement showers – 45 mm – linear drainage

Hard foam channel support element with 4-sided gradient, integrated and sealed floor channel drain **70 x 750 mm** on shorter side, cover rail made from stainless steel, with odour trap, height adjustable with height adapter from 5–17 mm.

	Product specifications					Suggested Installation Kit TUB-KIT UNI GK
	Article-number	Article-name	Article-description	Nominal formats/dimensions length x width x height	Unit	
	LTUBE97001	TUB-LINE BOL 1800/900	can be cut to length to minimum 900 x 1200 mm, slope area from 900 x 1200 mm	1800 x 900 x 30/45 mm	Piece	

B Floor drain support – linear drainage

Floor drain support DN 50, without odour trap.

	Product specifications				
	Article-number	Article-name	Article-description	Unit	
	LTUBE1112	TUB-LINE BA-W	horizontal	Piece	
	LTUBE1113	TUB-LINE BA-S	vertical	Piece	

C DN 50 to British standard adaptor

All LUX ELEMENTS® drains require a TUB-BAZ BST adaptor or similar.

	Product specifications				
	Article-number	Article-name	Article-description	Unit	
	LTUBE1190	TUB-BAZ BST	made of PVC	Piece	

D Shower tray installation Kit

LUX ELEMENTS offers installation Kits complete with adhesive, tape sealer, waterproofing tape and two internal corners.

	Product specifications				
	Article-number	Article-name	Article-description	Unit	
	LTUBE1090	TUB-KIT UNI	5 kg COL-AK, 3,5 kg DRY-ASK, 10 m DRY-DB, 2 pieces DRY-DBIE (inner corners)	Kit	
	LTUBE1098	TUB-KIT UNI GK	3 x 5 kg COL-AK, 3,5 kg DRY-ASK, 10 m DRY-DB, 2 pieces DRY-DBIE (inner corners)	Kit	
	LTUBE1099	TUB-KIT UNI GG	5 x 5 kg COL-AK, 3,5 kg DRY-ASK, 10 m DRY-DB, 2 pieces DRY-DBIE (inner corners)	Kit	





Professional Wetrooms

Step up showers

100 mm step up trays are suitable for installations where the drain needs to be lifted above the substrate. They can be trimmed down and are ideal for awkward or unusual size spaces.



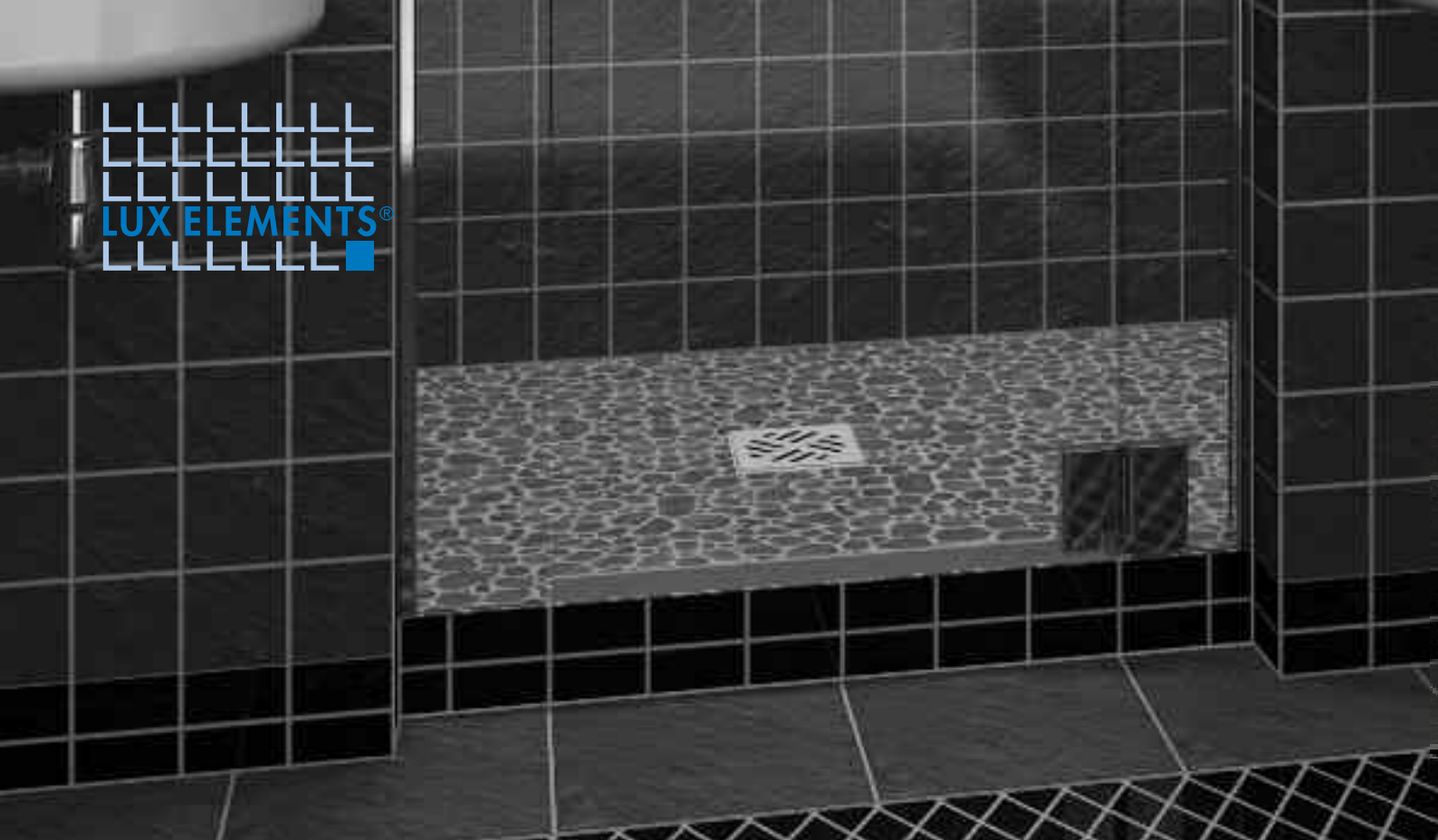

Specifications and prices

Step up shower trays

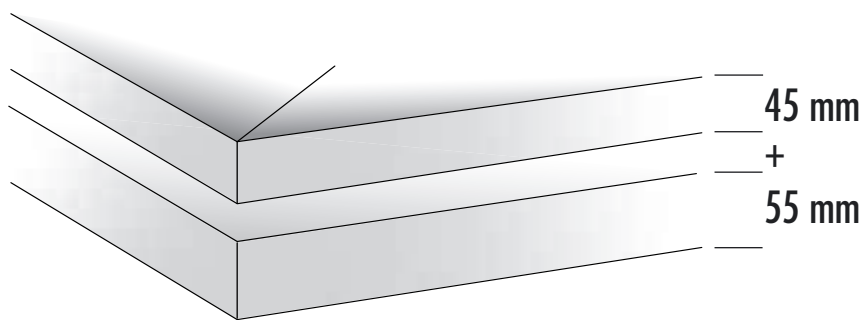

NOTE:
 The components you need to install your shower tray are assembled by a certain principle. Please see page 51.

A Walk in and bath tub replacement showers – 100 mm – point drainage

Hard foam shower base elements, rectangular, with installed and sealed-in floor drain fitting frame 135 x 135 mm, for mineral substrates and timber sub-constructions, with a sufficient installation height for drain fittings and pipes.

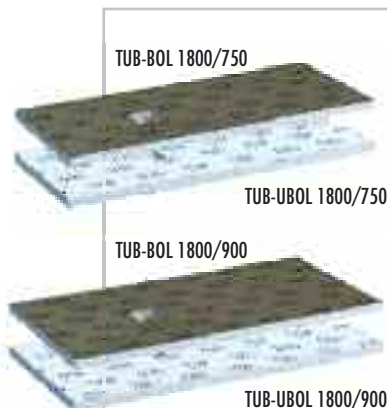

Product specifications							Suggested Installation Kit
Article-number	Article-name	Article-description	Nominal formats/dimensions length x width x height	Unit			
LTUBE18016	TUB-BOL 1800/750	can be cut to length to minimum 750 x 1200 mm, slope area from 750 x 1200 mm, drain in the slope area in the centre	1800 x 750 x 30/45 mm	Piece			TUB-KIT UNI GG
LTUBE18017	TUB-UBOL 1800/750	substrate element	1800 x 750 x 55 mm	Piece			
LTUBE18018	TUB-BOL 1800/900	can be cut to length to minimum 900 x 1200 mm, slope area from 900 x 1200 mm, drain in the slope area in the centre	1800 x 900 x 30/45 mm	Piece			TUB-KIT UNI GG
LTUBE18019	TUB-UBOL 1800/900	substrate element	1800 x 900 x 55 mm	Piece			

A Step up showers – 100 mm – point drainage

Hard foam shower base elements, square or rectangular, with installed and sealed-in floor drain fitting frame 135 x 135 mm in the corner or in the center. All are available with substrate elements.

	Product specifications						Suggested Installation Kit
	Article-number	Article-name	Article-description	Nominal formats/dimensions length x width x height	Unit		
TUB-EQ	LTUBE10001	TUB-EQ 900	corner drain	900 x 900 x 30/45 mm	Piece		TUB-KIT UNI GG
	LTUBE11111	TUB-UQ 900	substrate element	900 x 900 x 55 mm	Piece		
TUB-UQ	LTUBE10002	TUB-EQ 1000	corner drain	1000 x 1000 x 30/45 mm	Piece		TUB-KIT UNI GG
	LTUBE11112	TUB-UQ 1000	substrate element	1000 x 1000 x 55 mm	Piece		
TUB-MQ	LTUBE10003	TUB-EQ 1200	corner drain	1200 x 1200 x 30/45 mm	Piece		TUB-KIT UNI GG
	LTUBE11113	TUB-UQ 1200	substrate element	1200 x 1200 x 55 mm	Piece		
TUB-UQ	LTUBE10101	TUB-MQ 900	centre drain	900 x 900 x 30/45 mm	Piece		TUB-KIT UNI GG
	LTUBE11111	TUB-UQ 900	substrate element	900 x 900 x 55 mm	Piece		
TUB-UQ	LTUBE10102	TUB-MQ 1000	centre drain	1000 x 1000 x 30/45 mm	Piece		TUB-KIT UNI GG
	LTUBE11112	TUB-UQ 1000	substrate element	1000 x 1000 x 55 mm	Piece		
TUB-UQ	LTUBE10103	TUB-MQ 1200	centre drain	1200 x 1200 x 30/45 mm	Piece		TUB-KIT UNI GG
	LTUBE11113	TUB-UQ 1200	substrate element	1200 x 1200 x 55 mm	Piece		
TUB-ER	LTUBE10104	TUB-MQ 1500	centre drain	1500 x 1500 x 30/45 mm	Piece		TUB-KIT UNI GG
	LTUBE11114	TUB-UQ 1500	substrate element	1500 x 1500 x 55 mm	Piece		
TUB-UR	LTUBE10601	TUB-ER 1200/900	off centre drain	1200 x 900 x 30/45 mm	Piece		TUB-KIT UNI GG
	LTUBE11812	TUB-UR 1200/900	substrate element	1200 x 900 x 55 mm	Piece		
TUB-UR	LTUBE10602	TUB-ER 1200/1000	off centre drain	1200 x 1000 x 30/45 mm	Piece		TUB-KIT UNI GG
	LTUBE11813	TUB-UR 1200/1000	substrate element	1200 x 1000 x 55 mm	Piece		
TUB-UR	LTUBE10603	TUB-ER 1400/900	off centre drain	1400 x 900 x 30/45 mm	Piece		TUB-KIT UNI GG
	LTUBE11815	TUB-UR 1400/900	substrate element	1400 x 900 x 55 mm	Piece		
TUB-MR	LTUBE10605	TUB-ER 1600/900	off centre drain	1600 x 900 x 30/45 mm	Piece		TUB-KIT UNI GG
	LTUBE11817	TUB-UR 1600/900	substrate element	1600 x 900 x 55 mm	Piece		
TUB-UR	LTUBE10701	TUB-MR 1000/800	centre drain	1000 x 800 x 30/45 mm	Piece		TUB-KIT UNI GG
	LTUBE11811	TUB-UR 1000/800	substrate element	1000 x 800 x 55 mm	Piece		
TUB-UR	LTUBE10702	TUB-MR 1200/900	centre drain	1200 x 900 x 30/45 mm	Piece		TUB-KIT UNI GG
	LTUBE11812	TUB-UR 1200/900	substrate element	1200 x 900 x 55 mm	Piece		
TUB-UR	LTUBE10706	TUB-MR 1600/900	centre drain	1600 x 900 x 30/45 mm	Piece		TUB-KIT UNI GG
	LTUBE11817	TUB-UR 1600/900	substrate element	1600 x 900 x 55 mm	Piece		

B Floor drain support – point drainage

Floor drain support DN 50, with odour trap, incl. 130 x 130 mm grate fitting frame made of ABS and 120 x 120 mm standard stainless steel grate; universal height adjustment to suit tile thickness.

	Product specifications			
	Article-number	Article-name	Article-description	Unit
	LTUBE1184	TUB-BAW-S	horizontal	Set
	LTUBE1180	TUB-BAS-S	vertical	Set



A Walk in and bath tub replacement showers – 100 mm – linear drainage

Hard foam channel support elements, rectangular, with integrated and sealed floor channel drain **70 x 750 mm** on shorter side, cover rail made from stainless steel, with odour trap, height adjustable with height adapter from 5–17 mm. For mineral substrates and timber sub-constructions, with a sufficient installation height for drain fittings and pipes.

 TUB-UBOL 1800/900	Product specifications					Suggested Installation Kit
	Article-number	Article-name	Article-description	Nominal formats/dimensions length x width x height	Unit	
	LTUBE97001	TUB-LINE BOL 1800/900	hard foam shower base element, can be cut to length to minimum 900 x 1200 mm, slope area from 900 x 1200 mm, drain in the slope area in the centre	1800 x 900 x 30/45 mm	Piece	TUB-KIT UNI GG
	LTUBE18019	TUB-UBOL 1800/900	substrate element	1800 x 900 x 55 mm	Piece	

B Floor drain support – linear drainage

Floor drain support DN 50, without odour trap.

 TUB-LINE BA-W	Product specifications			
	Article-number	Article-name	Article-description	Unit
	LTUBE1112	TUB-LINE BA-W	horizontal	Piece
 TUB-LINE BA-S	LTUBE1113	TUB-LINE BA-S	vertical	Piece

C DN 50 to British standard adaptor

All LUX ELEMENTS® drains require a TUB-BAZ BST adaptor or similar.

 TUB-BAZ BST	Product specifications			
	Article-number	Article-name	Article-description	Unit
	LTUBE1190	TUB-BAZ BST	made of PVC	Piece

D Shower tray installation Kit

LUX ELEMENTS offers installation Kits complete with adhesive, tape sealer, waterproofing tape and two internal corners.

 TUB-KIT UNI TUB-KIT UNI GK UNI GG	Product specifications			
	Article-number	Article-name	Article-description	Unit
	LTUBE1090	TUB-KIT UNI	5 kg COL-AK, 3,5 kg DRY-ASK, 10 m DRY-DB, 2 pieces DRY-DBIE (inner corners)	Kit
	LTUBE1098	TUB-KIT UNI GK	3 x 5 kg COL-AK, 3,5 kg DRY-ASK, 10 m DRY-DB, 2 pieces DRY-DBIE (inner corners)	Kit
	LTUBE1099	TUB-KIT UNI GG	5 x 5 kg COL-AK, 3,5 kg DRY-ASK, 10 m DRY-DB, 2 pieces DRY-DBIE (inner corners)	Kit

Professional Wetrooms

Flexible shower elements

If a screed floor with a slope already exists, then a shower drain element or a floor channel drain integrated in hard foam support element is the ideal solution for the secure installation of a shower.

Specifications and prices

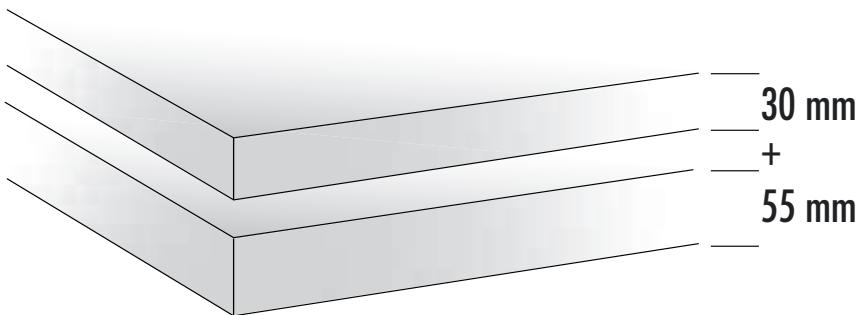

Combination possibilities

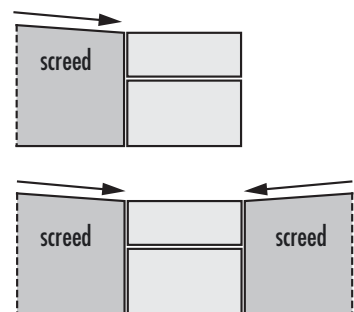

A Shower drain element – 30 mm – point drainage

Hard foam shower drain element with integrated floor drain support frame 135 x 135 mm and loose sealing sleeve 400 x 400 mm.

TUB-MQ SET 300	Product specifications				
	Article-number	Article-name	Article-description	Nominal formats/dimensions length x width x height	Unit
	LTUBE1111	TUB-MQ SET 300	with substrate element TUB-UMQ 300 x 300 x 55 mm	300 x 300 x 30 mm	Set

B Floor drain support – point drainage

Floor drain support DN 50, with odour trap, incl. 130 x 130 mm grate fitting frame made of ABS and 120 x 120 mm standard stainless steel grate; universal height adjustment to suit tile thickness.

	Product specifications			
	Article-number	Article-name	Article-description	Unit
	LTUBE1184	TUB-BAW-S	horizontal	Set
	LTUBE1180	TUB-BAS-S	vertical	Set



A Floor channel drains – 30 mm – linear drainage

Floor channel drain **70 x 650 mm** or **70 x 750 mm** or **70 x 850 mm**, with cover rail and tiling aid made of brushed stainless steel, cover rail tileable on the rear side, with odour trap, height adjustable with height adaptor from 5–17 mm, integrated in hard foam support element, including sealing sleeve 1300 x 300 mm.

Product specifications				
Article-number	Article-name	Article-description	Nominal formats/dimensions length x width x height	Unit
LTUBE95008	TUB-LINE RT 900/200 (650)	floor channel drain 70 x 650 mm, including substrate element 200 x 900 x 55 mm	200 x 900 x 30 mm	Set
LTUBE95001	TUB-LINE RT 900/200 (750)	floor channel drain 70 x 750 mm, including substrate element 200 x 900 x 55 mm	200 x 900 x 30 mm	Set
LTUBE95003	TUB-LINE RT 1200/200 (850)	floor channel drain 70 x 850 mm, including substrate element 200 x 1200 x 55 mm	200 x 1200 x 30 mm	Set

B Floor drain support – linear drainage

Floor drain support DN 50, without odour trap.

Product specifications				
Article-number	Article-name	Article-description	Unit	
LTUBE1112	TUB-LINE BA-W	horizontal	Piece	
LTUBE1113	TUB-LINE BA-S	vertical	Piece	

C DN 50 to British standard adaptor

All LUX ELEMENTS® drains require a TUB-BAZ BST adaptor or similar.

Product specifications				
Article-number	Article-name	Article-description	Unit	
LTUBE1190	TUB-BAZ BST	made of PVC	Piece	





Professional Wetrooms

TUB-WALL

A new shower experience on a continuous floor surface

The TUB-WALL Shower Concept from LUX ELEMENTS is the ultimate for those seeking style and practicality.

With the drain neatly hidden in the wall there is now the opportunity to tile the floor with no cuts or enveloping. With its single-sided gradient it is possible to use tiles as large as 900 x 900 mm without cutting them. With the additional wall elements you can locate services inside the hard foam making them proud of the main wall, and at the same time cut in features like niches and shelves. Finally with the TUB-WALL-SET you have a curb surround to ensure all the water remains within the shower area and not outside like many other wetroom systems, stunning yet practical!



Professional Wetrooms

TUB-WALL-SET

Shower module for easy installation

LUX ELEMENTS offers the shower module TUB-WALL-SET for easy installation, consisting of:

- **1 Shower drain element with integrated wall drain,**
tileable cover and loose sealing sleeve
- **1 Adaptor**
DN 50 to British Standard
- **1 Gradient element**
single-sided gradient 1800 x 900 x 70/85 mm
- **2 Curbs as a water barrier**
1524 x 114 x 127 mm
- **4 Wall-Boards**
900 x 600 x 100 mm
- **3 cartridges mounting adhesive and 1 bottle primer**

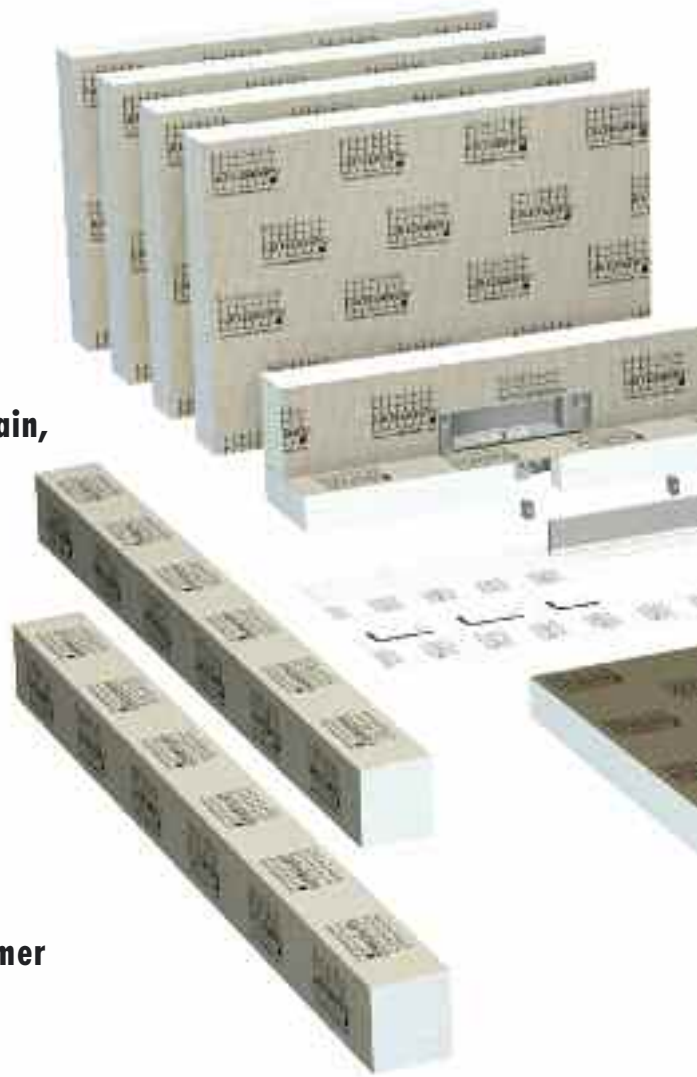

Different design options

Many configurations can be achieved with the TUB-WALL-SET. Below are some examples.

Option 1: Full height with niche and curb (2 walls)

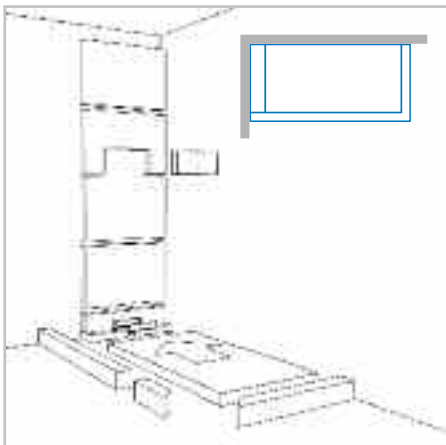

Option 2: Half height with shelf and curb (2 walls)

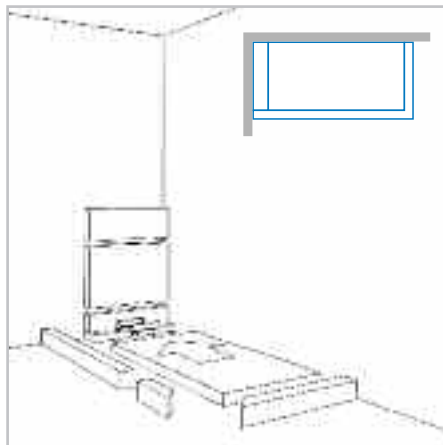

Option 3: Full height with curb (3 walls)

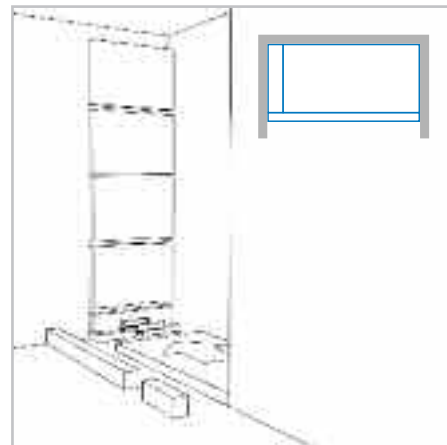

TUB-WALL-KIT

Installation is easy, fast and clean. The supplied sealing sleeve ensures a reliable sealing around the drain area.

To facilitate the installation even more LUX ELEMENTS offers an installation Kit complete with adhesive, tape sealer, reinforcement tape for transitions, waterproofing tape and internal corners.

LUX ELEMENTS fixing and sealing components have been developed over many years. They are very important to the overall installation and ensure warranties are maintained.

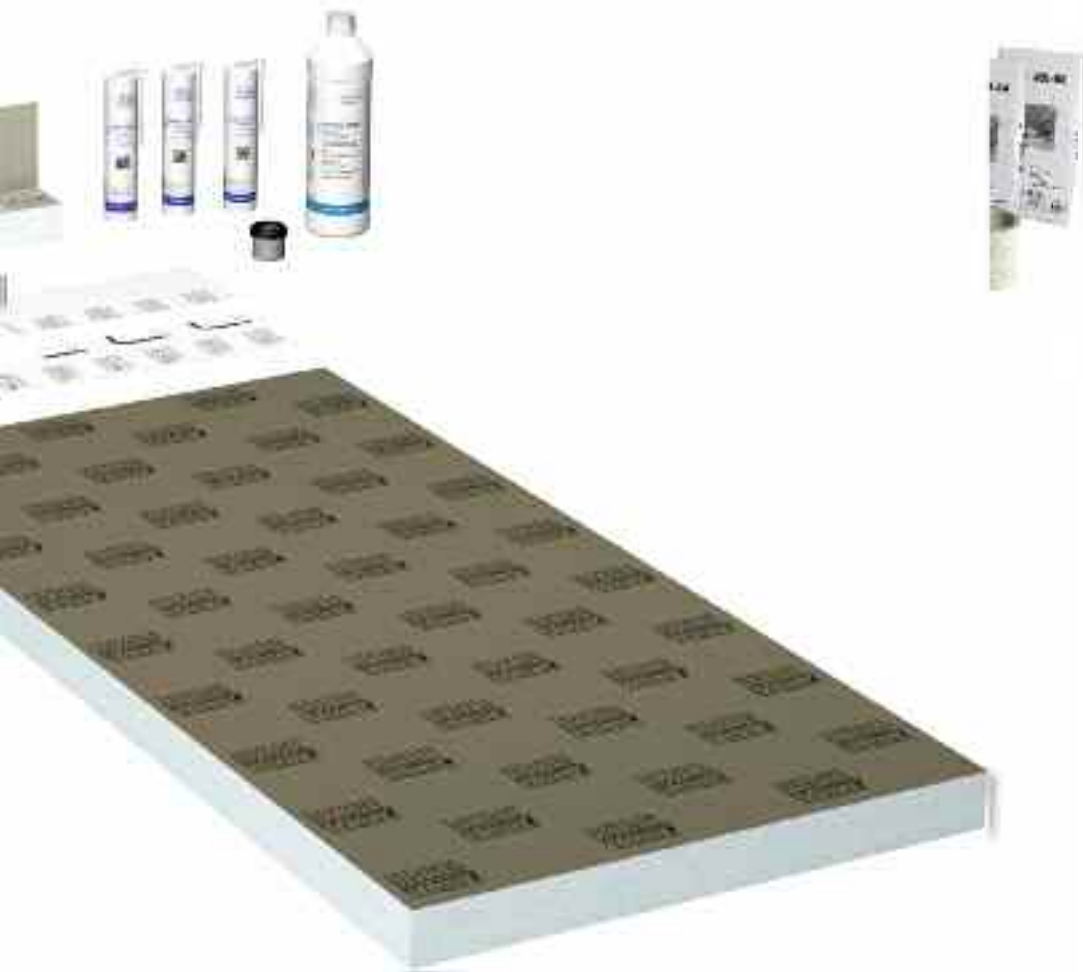

TUB-WALL-SET

Shower drain element with integrated wall drain, with tileable cover from stainless steel, with odour trap.

		Product specifications		
Article-number	Article-name	Article-description	Unit	
LTUBE119311	TUB-WALL-SET	Prefabricated elements made of hard foam support material. Mounting set consisting of: 1 shower drain element with integrated wall drain TUB-WALL RT 1 900/200 with loose sealing sleeve and tileable cover from stainless steel, 900 x 200 x 70 mm; 1 TUB-BAZ BST adaptor, 1 hard foam descendent gradient element, sealed, with 1-sided gradient 1800 x 900 x 70/85 mm; 2 RELAX-CU-F 5 curb 1524 x 114 x 127mm; 4 x ELEMENT-EL board 900 x 600 x 100 mm; incl. mounting accessory: 3 cartridges COL-MK mounting adhesive and 1 bottle COL-HSV primer	Set	
LTUBE119312	TUB-WALL-KIT	Installation Kit consisting of: 5 x 5 kg COL-AK fixing adhesive, 2x 3,5 kg DRY-ASK sealing filler, 10 m DRY-DB sealing tape, 10 m ARM-100 SK reinforcement for transitions, 4 pieces DRY-DBIE sealing tape for inner corners	Kit	

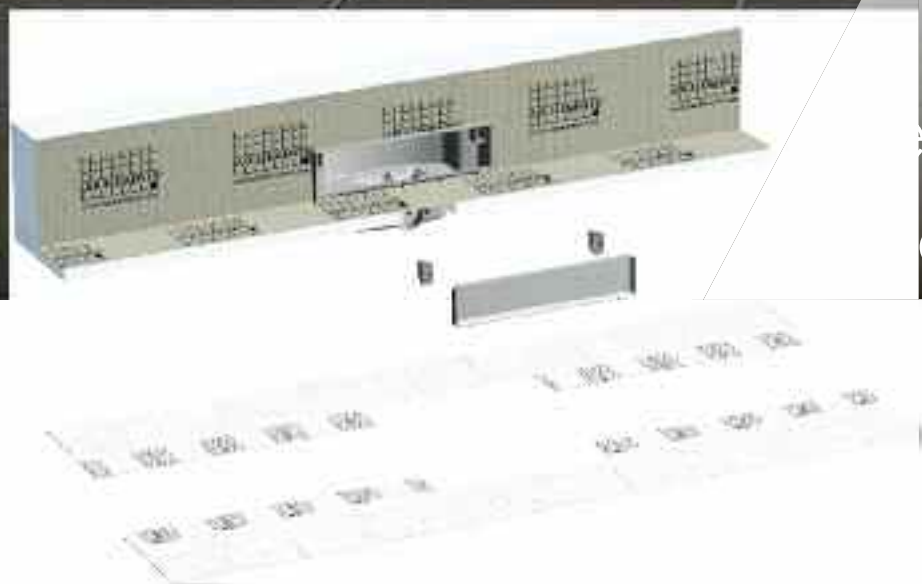

level
access

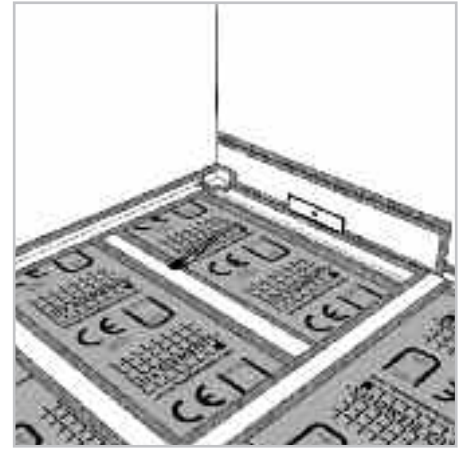
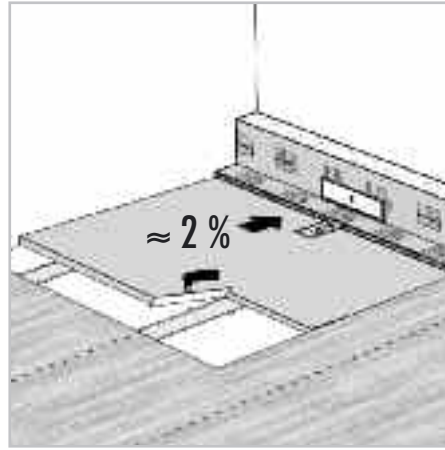
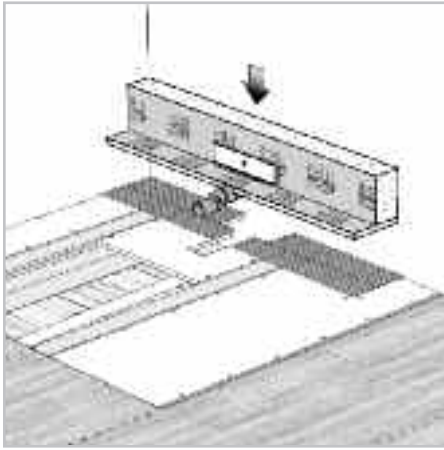

Professional Wetrooms

TUB-WALL RT 1 H 1200/200

For use on wooden floor constructions

The TUB-WALL RT1 H in-wall drain is only 20 mm in height so ideal for installations on timber substrates where level access is preferred. The thoughtful drain design enables the use of a variety of tile finishes including large format thus minimising the need for cutting and enveloping during installation.

Bench for the installation of a TUB-WALL RT 1 H 1200/200

The RELAX-BA-SOLO-G-W bench, new from LUX ELEMENTS, integrates drainage into a practical customised seating solution. The TUB-WALL RT 1 H in-wall drain sits neatly inside the bench enabling creative design within the shower area.



■ TUB-WALL RT 1 H 1200/200

Hard foam shower drain element with integrated wall drain, with tileable cover from stainless steel, with odour trap, for use on wooden floor constructions.



Product specifications					
Article-number	Article-name	Article-description	Nominal formats/dimensions length x width x height	Unit	
LTUBE9319	TUB-WALL RT 1 H 1200/200	with loose sealing sleeve 370 x 1300 mm, single-sided gradient	200 x 1200 x 20 mm	Set	
TUB-BAZ BST	LTUBE1190	TUB-BAZ BST	made of PVC		Piece





Professional Wetrooms

Individual, special manufacture

LUX ELEMENTS offer customised shower tray solutions under the name TUB PLUS. Any size or style in either linear or point drainage is more or less achievable.

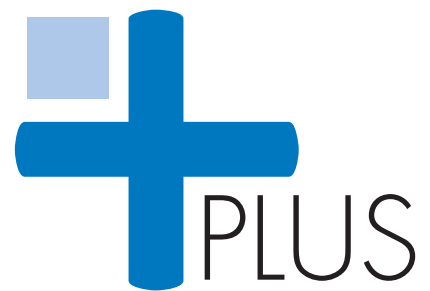

- **Custom solutions**

to suit specific requirements.

- **Ideal for either domestic or commercial projects.**

- **Detailed drawings provided for sign off**

to ensure all dimensions are correct.

- **Approx 2 to 3 weeks delivery time**

after signing of technical drawings.



- **NOTE:**

For further information please refer to our website or request a copy of our brochure "The Experience – Shower bases".



Professional Wetrooms

Sophisticated drain grates for every taste



In addition to the complete set with a standard grate made of stainless steel there is a combinable floor drain system with a choice of five designer grates for a particularly sophisticated drain design. E.g. various brushed stainless steel grates as well as a grate with a cover that can be tiled. **Luxury that's worth the price!**

B Combinable floor drain systems – point drainage

In this floor drain system, different floor drain supports, vertical or horizontal can be combined with five grate variants (including grate fitting frame).

Floor drain support

Floor drain support DN 50, horizontal or vertical, with odour trap

		Product specifications			
		Article-number	Article-name	Article-description	Unit
		LTUBE1101	TUB-BA-W	horizontal	Set
		LTUBE1102	TUB-BA-S	vertical	Set



Grate fitting frame with design grate

Grate fitting frame made of ABS with universal height adjustment to suit tile thickness and drain grate

		Product specifications				
		Article-number	Article-name	Article-description	Nominal formats/dimensions length x width	Unit
		LTUBE1104	TUB-RA-DA	frame and design grate 'ANGOLO' made of stainless steel	external frame dimensions: 132 x 132 mm, grate: 120 x 120 mm	Set
		LTUBE1105	TUB-RA-DC	frame and design grate 'CUBE' made of stainless steel	external frame dimensions: 132 x 132 mm, grate: 120 x 120 mm	Set
		LTUBE1106	TUB-RA-DM	frame and design grate 'MARE' made of stainless steel	external frame dimensions: 132 x 132 mm, grate: 120 x 120 mm	Set
		LTUBE1107	TUB-RA-DL	frame and design grate 'LUMEN' made of stainless steel	external frame dimensions: 132 x 132 mm, grate: 120 x 120 mm	Set
		LTUBE1108	TUB-RA-DV	frame and tileable cover 'VARI' made of stainless steel	external frame dimensions: 132 x 132 mm, cover: 110 x 110 mm	Set

Note: All LUX ELEMENTS® drains require a TUB-BAZ BST adaptor or similar



NOTE:

For further information please refer to our website or request a copy of our brochure "Accentuation – stainless steel design grates".



Professional Wetrooms

Curbs

Optional curbs between the shower and the floor are a suitable method of protecting the bathroom against splash-water from the shower. LUX ELEMENTS has two standard curbs in different lengths for this purpose.

■ Curbs

Curb as a water barrier



Product specifications				
Article-number	Article-name	Article-description	Nominal formats/dimensions length x width x height	Unit
LREL8100	RELAX-CU-F 5	curb	1524 x 114 x 130/127 mm	Piece
LREL8101	RELAX-CU-F 8	curb	2438 x 114 x 130/127 mm	Piece







Professional Wetrooms

Niches

Niches are an elegant and space-saving solution for shelves. LUX ELEMENTS offers four prefabricated niches made of hard foam support material which can be combined ideally with LUX ELEMENTS® wall panels.

Why not illuminate your niche and create a visual highlight with the RELAX-NI-LI warm white LED light. This is available for models M/L/XL. This can also be used in customised niches of your own size and design.



■ Niches

Prefabricated from ELEMENT-EL 12



Product specifications

Article-number	Article-name	Article-description	Nominal formats/dimensions length x width x height	Unit
LREL8200	RELAX-NI-S	niche	external: 203 x 406 x 89 mm / internal: 102 x 305 x 77 mm	Piece
LREL8201	RELAX-NI-M	niche	external: 406 x 406 x 89 mm / internal: 305 x 305 x 77 mm	Piece
LREL8202	RELAX-NI-L	niche with one shelf	external: 559 x 406 x 89 mm / internal: 457 x 305 x 77 mm	Piece
LREL8203	RELAX-NI-XL	niche with two shelves	external: 1070 x 406 x 89 mm / internal: 968 x 305 x 77 mm	Piece
LREL8207	RELAX-NI-LI	light strip (warm white) for RELAX-NI-M/L/XL, loose, including hard foam support element (d = 10 mm) with milling for on-site installation		Set
LREL8206	RELAX-NI-LZ	accessories for the RELAX-NI-LI at extra cost: LED power supply unit, 30 Watt 12 Volt IP 66, up to eight LREL8207 can be connected		Set



Professional Wetrooms

Wall and floor panels

LUX ELEMENTS®-ELEMENT-VK panels are an ideal substrate for walls and floors. They are water resistant, anti-bacterial, insulating, with vapour barrier characteristics and highly stable for tile finishes. LUX ELEMENTS®-ELEMENT-VK panel is a more suitable material for wetroom construction than plasterboard and timber, delivering both total waterproofing and vapour control.

■ Walls

LUX ELEMENTS®-ELEMENT-VK 12 mm panels can be screwed directly to metal or timber studwork to replace timber or plasterboard. For block or brickwork they can be glued with our special adhesive COL-AK.

■ Floors

Panels no thicker than 12 mm are perfect for use on floors before tiling. Whether constructing on timber or concrete floors, the panels form a floating layer of tile by simply disconnecting the tile from the surface below, this creates a more stable tile layer.

When creating a professional wetroom with LUX ELEMENTS®-TUB shower trays our 6 mm or 12 mm panels are ideal. They will bring the floor height level with your tray and give you total waterproofing.

■ Extension of shower trays

No matter whether your choice of a LUX ELEMENTS®-TUB shower tray is a 'Level Access', 'Low Profile' or 'Step Up' solution – our matching LUX ELEMENTS®-ELEMENT-VK panels are always a perfect way of extending the shower area, i.e. for a walk in zone or a seat.

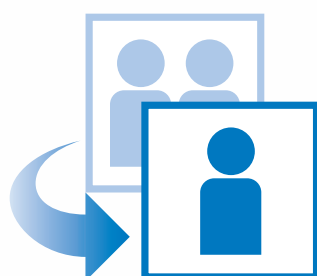

LUX ELEMENTS®-ELEMENT-VK 12 mm panels are available in two lengths. Due to its size, the shorter version, also called "Baby panel" or "One-man panel", is particularly easy to handle and is suitable for wall and floor installation.

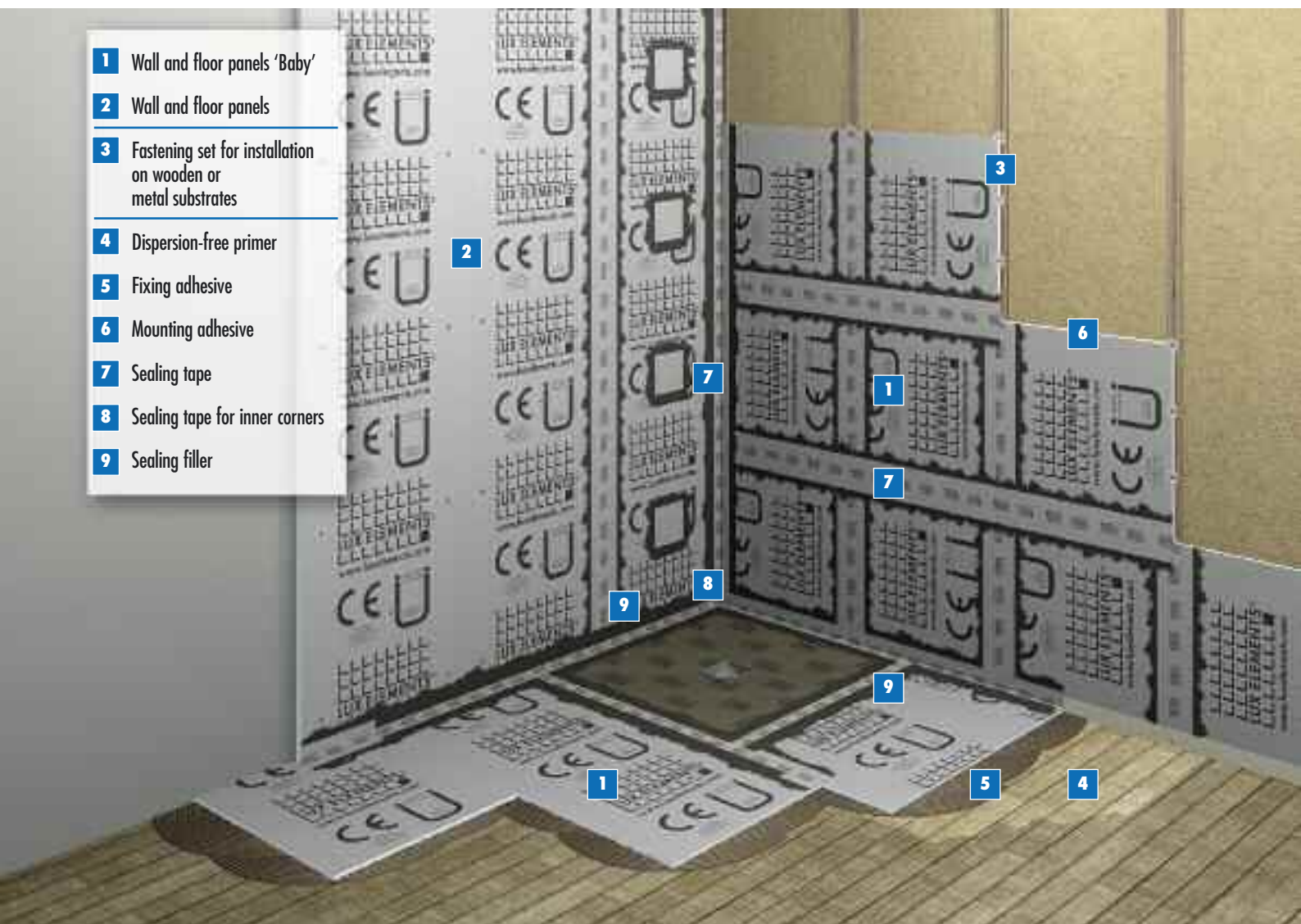

- 1** Wall and floor panels 'Baby'
- 2** Wall and floor panels
- 3** Fastening set for installation on wooden or metal substrates
- 4** Dispersion-free primer
- 5** Fixing adhesive
- 6** Mounting adhesive
- 7** Sealing tape
- 8** Sealing tape for inner corners
- 9** Sealing filler

Wall and floor panels

ELEMENT-VK Baby		Product specifications				
Article-number	Article-name	Article-description	Nominal formats/dimensions length x width x thickness	Unit		
LELEE3009	ELEMENT-VK Baby 6	Hard foam support element, fleece backed on one side	1250 x 600 x 6 mm	m ²		
LELEE3010	ELEMENT-VK Baby 12	Hard foam support element, fleece backed on one side	1250 x 600 x 12 mm	m ²		
LELEE3011	ELEMENT-VK Baby 20	Hard foam support element, fleece backed on one side	1250 x 600 x 20 mm	m ²		
LELEE3012	ELEMENT-VK Baby 30	Hard foam support element, fleece backed on one side	1250 x 600 x 30 mm	m ²		
LELEE3013	ELEMENT-VK Baby 50	Hard foam support element, fleece backed on one side	1250 x 600 x 50 mm	m ²		
LELEE3001	ELEMENT-VK 12	Hard foam support element, fleece backed on one side	2500 x 600 x 12 mm	m ²		
LELEE3002	ELEMENT-VK 20	Hard foam support element, fleece backed on one side	2500 x 600 x 20 mm	m ²		
LELEE3005	ELEMENT-VK 50	Hard foam support element, fleece backed on one side	2500 x 600 x 50 mm	m ²		

Required installation components

Fixings

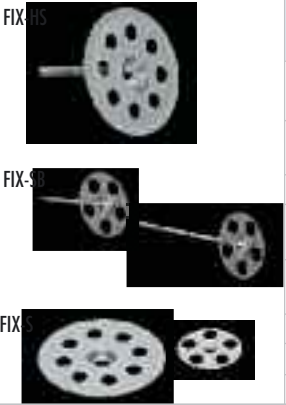
		Product and packaging specifications				
		Fixings				
Article-number	Article-name	Article-description	Nominal format/dimensions	Contents ind. packaging	Unit	
LFIXZ1111	FIX-HS 80S70	Screw with washer for wooden substrate	screw 80 mm washer \varnothing 70 mm	50 Sets	Set	
LFIXZ1112	FIX-SB 45S35	Fastening set for installation on wooden or metall supports	screw 45 mm, washer \varnothing 35 mm	50 Sets	Set	
LFIXZ1113	FIX-SB 80S35	Fastening set for installation on wooden or metall supports	screw 80 mm, washer \varnothing 35 mm	50 Sets	Set	
LFIXZ1114	FIX-S 35	Washer, galvanised	\varnothing 35 mm	50 Pieces	Piece	
LFIXZ1115	FIX-S 70	Washer, galvanised	\varnothing 70 mm	50 Pieces	Piece	

Adhesives and tapes

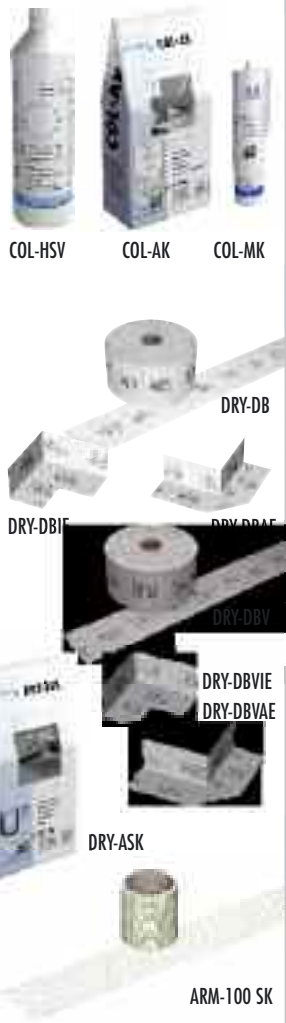
		Product and packaging specifications				
		Panel fixing adhesives				
Article-number	Article-name	Article-description		Contents ind. packaging	Unit	
LCOLZ1012	COL-HSV	Dispersion-free primer		1000 ml	Piece	
LCOLZ1001	COL-AK	Fixing adhesive		25 kg	kg	
LCOLZ1014	COL-AK	Fixing adhesive		5 kg	kg	
LCOLZ1036	COL-MK	Mounting adhesive		290 ml	Piece	
		Product and packaging specifications				
		Waterproofing tape and adhesive				
Article-number	Article-name	Article-description	Nominal format/dimensions	Contents ind. packaging	Unit	
LDRYZ2001	DRY-DB	Sealing tape	100 mm	10 meter	meter	
LDRYZ2002	DRY-DB	Sealing tape	100 mm	50 meter	meter	
LDRYZ2103	DRY-DBIE	Sealing tape for inner corners		1 Piece	Piece	
LDRYZ2104	DRY-DBAE	Sealing tape for outer corners		1 Piece	Piece	
LDRYZ3001	DRY-DBV	Sealing tape for ELEMENT-VK	120 mm	30 meter	meter	
LDRYZ3002	DRY-DBV	Sealing tape for ELEMENT-VK	120 mm	10 meter	meter	
LDRYZ3101	DRY-DBVIE	Sealing tape for ELEMENT-VK for inner corners		1 Piece	Piece	
LDRYZ3102	DRY-DBVAE	Sealing tape for ELEMENT-VK for outer corners		1 Piece	Piece	
LDRYZ1016	DRY-ASK	Sealing filler		3,5 kg	kg	
LDRYZ1012	DRY-ASK	Sealing filler		20 kg	kg	
		Product and packaging specifications				
		Non waterproof reinforcement tape				
Article-number	Article-name	Article-description	Nominal format/dimensions	Contents ind. packaging	Unit	
LARMZ1001	ARM-100 SK	Reinforcement for transitions*	100 mm	90 meter	meter	
LARMZ1007	ARM-100 SK	Reinforcement for transitions*	100 mm	20 meter	meter	

* self-adhesive design



NOTE:

For other useful tips and tricks on how to use LUX ELEMENTS®-ELEMENT-VK please refer to our website or request a copy of our installation brochure "The Construction".

Professional Wetrooms

Two drainage versions

The centrepiece of the shower area is the shower base. Whether in a corner or as a replacement for a bath tub, whether as a step up on the floor or a level with the floor solution, LUX ELEMENTS offers a suitable model for every application in two drainage versions, point and linear.

LUX ELEMENTS®-TUB

Tileable shower bases, square or rectangular, with sealed central or off-centre **point drainage** and 4-sided slope in many shapes and sizes.

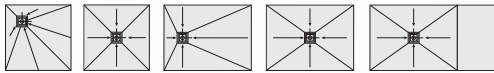

LUX ELEMENTS®-TUB-LINE

Tileable shower bases, square or rectangular, with 4-sided slope with sealed-in **floor channel drain** in various sizes.

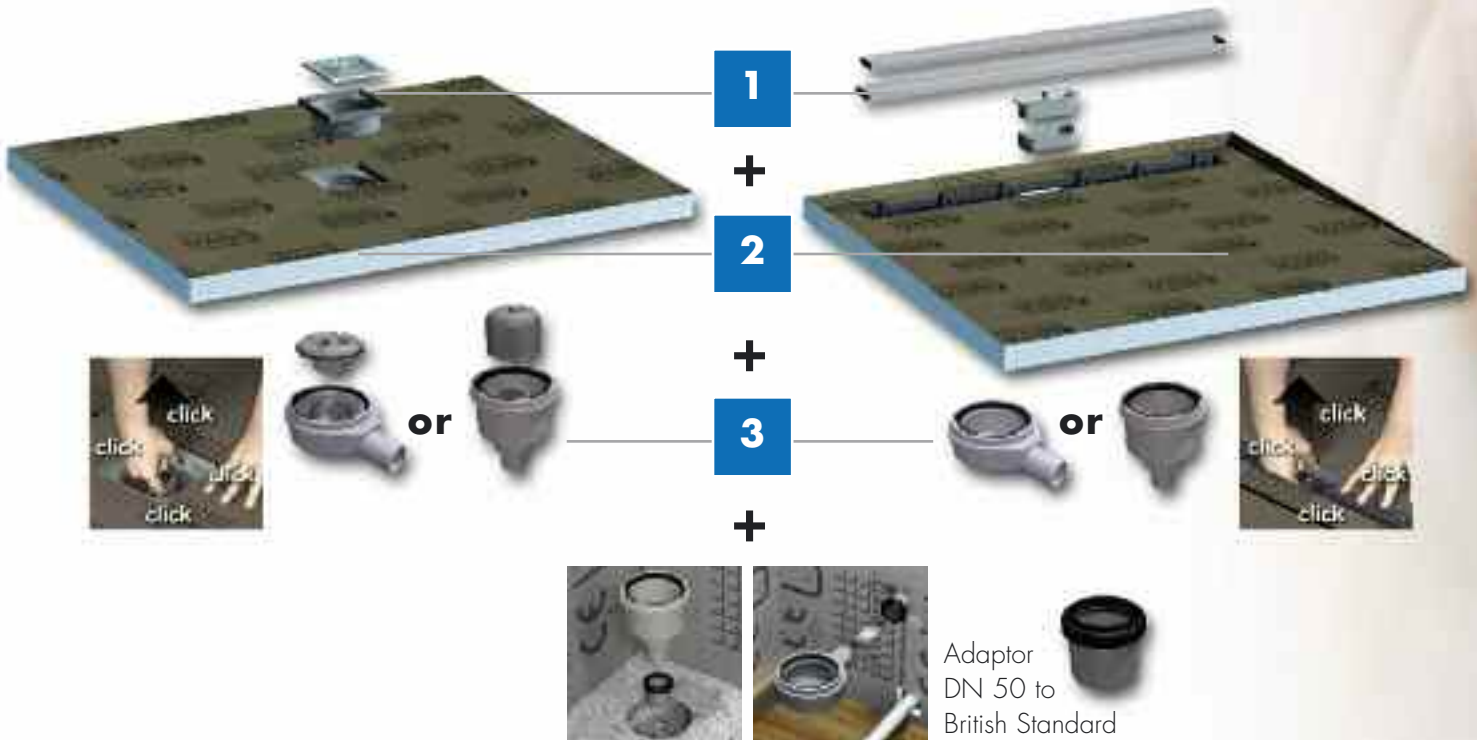
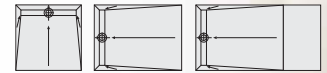

1 Two drainage versions – Point drainage with height-adjustable grate fitting frame and grate, or linear drainage with reversible cover rail for two surface variants, tiled or stainless steel, height adaptable.

2 Shower base element – Equipped with factory-fitted seal and 4-sided slope as well as sealed-in grate or channel fitting frame for high security.

3 Drain connection fitting, vertical or horizontal – For point drainage with odour trap, the linear drainage has an odour trap within the drain channel. Secure and fast installation by means of click system.

Adaptor DN 50 to British Standard – Fits all LUX ELEMENTS® floor drain supports.



Professional Wetrooms

What components do I need to install my shower tray?

Below is a list of required components for either point or linear shower trays. By following the **ABCD steps** when specifying your shower tray you won't miss anything needed for the installation.

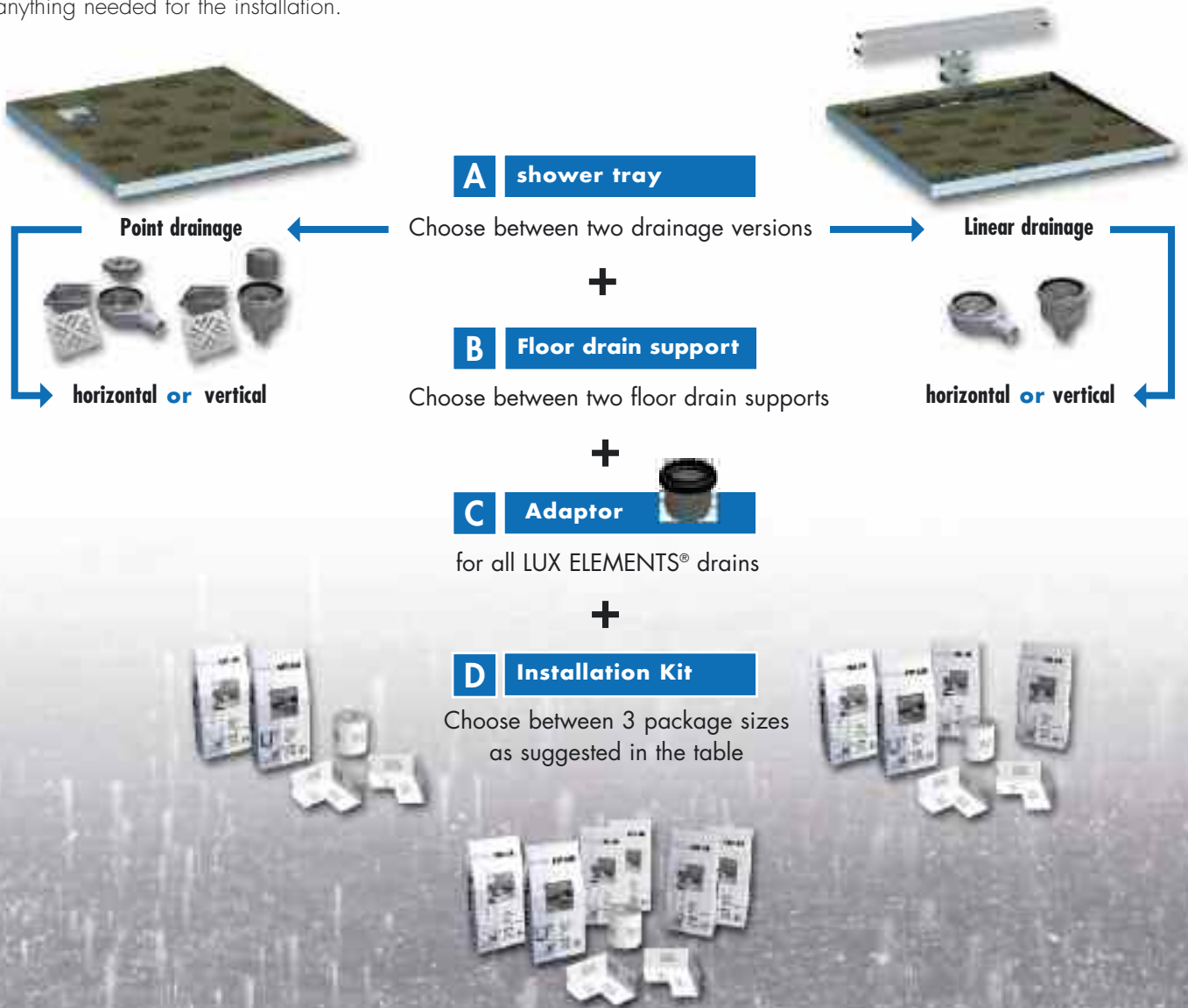

How to choose your shower tray components

For example:



Level access shower tray, square, corner drain, with horizontal floor drain support					
Article-number	Article-name	Article-description	Nominal formats/dimensions width x length x height	Unit	
LTUBE17001	TUB-HEQ 900	square, corner drain	900 x 900 x 15/30 mm	Piece	A
LTUBE1184	TUB-BAW-S	floor drain support DN 50 horizontal, with odour trap, incl. grate fitting frame made of ABS and standard stainless steel grate; universal height adjustment to suit tile thickness	external frame dimensions: 130 x 130 mm, grate: 120 x 120 mm	Set	B
LTUBE1190	TUB-BAZ BST	made of PVC		Piece	C
LTUBE1090	TUB-KIT UNI	5 kg COL-AK, 3,5 kg DRY-ASK, 10 meter DRY-DB, 2 pieces DRY-DBIE (inner corners)		Set	D
Complete price for your shower tray					=

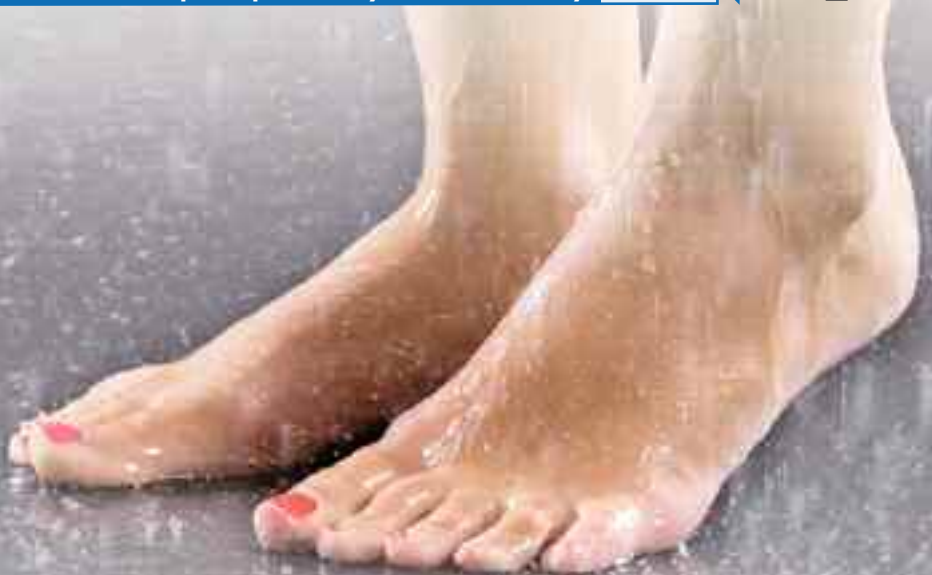

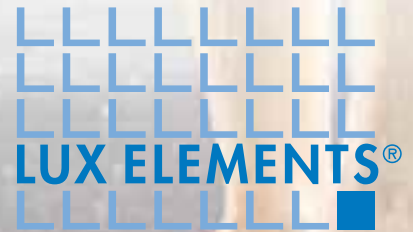

For your order

please contact:

MAIL: sales.enquiries@luxelements.co.uk

WEB: www.luxelements.com



Installation videos on www.m.luxelements.com or visit our new YouTube-Channel on www.youtube.com/user/luxelementscom

(D)

LUX ELEMENTS GmbH & Co. KG

An der Schusterinsel 7

D - 51379 Leverkusen-Opladen

Tel. +49 (0)2171/7212-0

Fax +49 (0)2171/7212-10

E-Mail info@luxelements.de

Web www.luxelements.com

(F)

LUX ELEMENTS S.A.S

ZI-31, rue d'Ensisheim

F - 68190 Ungersheim

Tél. +33 (0) 3 89 83 69 79

Fax +33 (0) 3 89 48 83 27

E-Mail info@luxelements.fr

Web www.luxelements.fr

UK Sales Manager

Christopher Smith

Tel. 07896-888084

E-Mail c.smith@luxelements.co.uk