

MADE IN GERMANY

# WETROOM SOLUTION

Secure. Fast. Individual.



## LUX ELEMENTS – WETROOM SOLUTION

Secure. Fast. Individual.



## Quality made in Germany

**Wetroom products from LUX ELEMENTS  
proven worldwide**

- Decades of experience
- High level of technical expertise
- International team
- Professional advice and support
- Modern flexible production methods
- Tried and tested building materials
- Quality control from the start
- Certified quality management

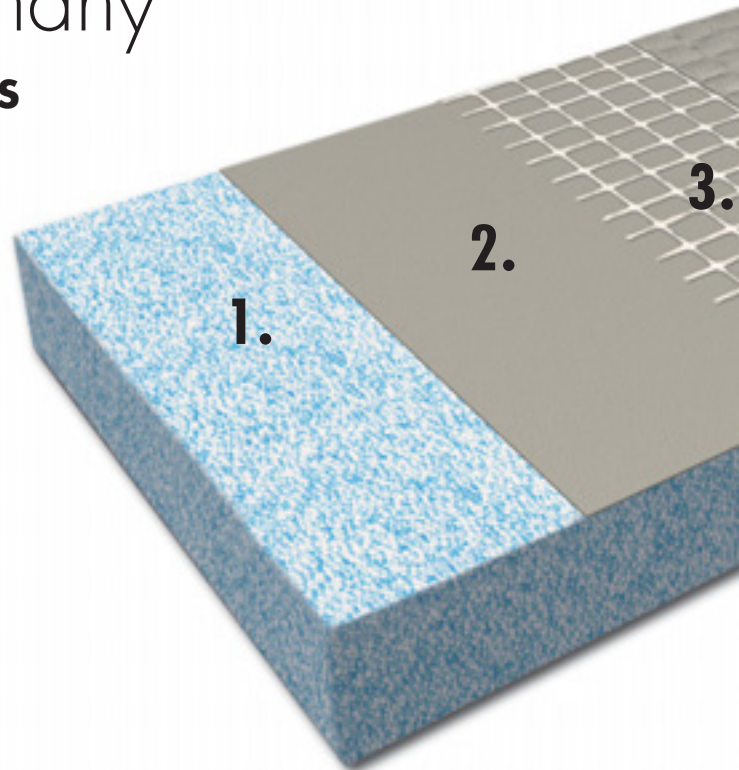



# LUX ELEMENTS® - THE ORIGINAL

- Environment-friendly
- Modern building material
- Proven material advantages
- Excellent for use in wet and humid conditions
- Very good machinability
- Continuous development
- Modern, system-oriented product range

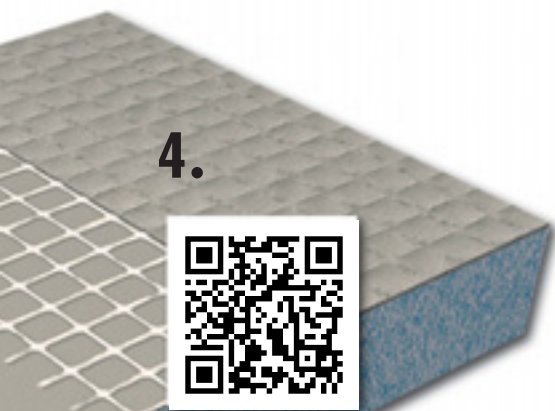

4.

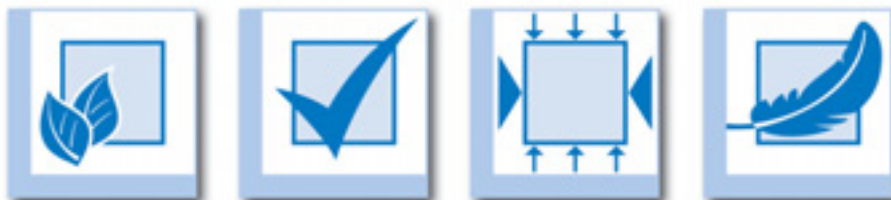

- environmentally friendly
- proven quality
- pressure-stable and rigid
- lightweight



- water-resistant
- fire-retarding
- insulating
- mould-resistant



- design variety
- alternative surfaces
- economical
- system-oriented

**The ORIGINAL can do!**

1. Polystyrene hard foam
2. Contact mortar layer
3. Glass fibre fabric
4. Coating mortar layer

## The most important tools

### Working with LUX ELEMENTS® hard foam support elements



#### ■ Cuts and notches

- Jig saw, serrated saw blade (e.g. type Bosch T31 3AW HCS) suitable for EL 4 to EL 100
- Angle grinder with diamond wheel suitable for EL 4 to EL 50
- Cutter suitable for EL 4 to EL 20
- Circular table saw



#### ■ Application of filler, for plastering and smoothing

- Bricklayer's trowel
- Smoothing trowel
- Notched trowel



#### ■ Fixing and mounting

For general work involved in mounting dowels, hammer fix plugs, screws, you need:

- Drill
- Cordless screwdriver
- Hammer

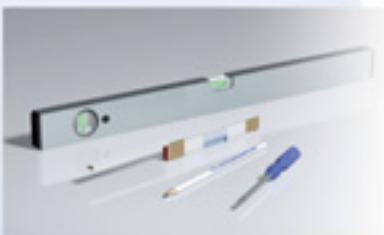

#### ■ Measuring, marking, aligning and checking

- Spirit Level
- Folding ruler
- Pencil
- Cross slot screwdriver
- Level for checking even surfaces



#### ■ Other important accessories are:

- Cartridge gun for pressing out glue cartridges
- Emery board for grinding uncoated edges of the ELEMENT construction panels
- Broad brush

# Cutting – techniques

## Working with LUX ELEMENTS® hard foam support elements

### ■ Cutting with the cutter – suitable for material thickness 4 to 20 mm · 3/16 to 13/16"



1a

Carry out a continuous cut on the top side of the hard foam support element along an applied ruler using the cutter.

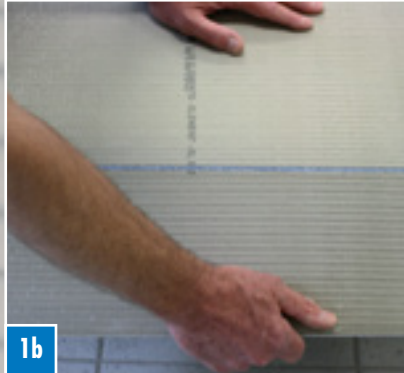

1b

A single cut is sufficient to split thinner panels (4 mm · 3/16"). For thicker panels from 6 mm to 20 mm · 1/4 to 13/16", bend along the cut.



1c

Then use the cutter to sever the mortar layer and the glassfibre fabric on the rear side of the hard foam support element in its bent state.

### ■ Cutting with the angle grinder (flex) – suitable for material thickness 4 to 50 mm · 3/16 to 1 15/16"



2a

Before cutting, draw a cutting line using a pencil and a ruler.



2b

Apply the angle grinder (segmented diamond grindingsheet) and cut through along the cutting line (very easy cutting).



2c

A smooth, clean cutting edge is created.

### ■ Cutting with the jig saw – suitable for material thickness 4 to 100 mm · 3/16 to 3 15/16"



3a

For a clean cut, we recommend a jig saw with a serrated blade (e.g. type Bosch T313AW HCS).



3b

Before the actual cut, draw a cutting line using a pencil and a ruler. Then cut to size along the line using the jig saw (very easy cut).

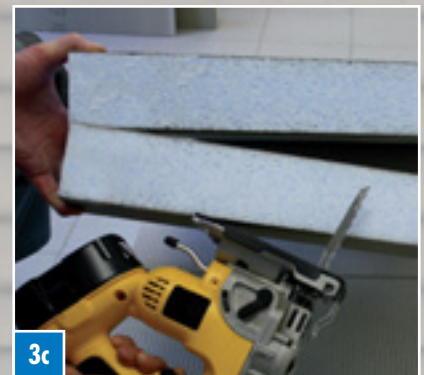

3c

Thick panels up to 100 mm · 3 15/16" can be cleanly cut using this technique. The jig saw is also particularly suitable for cutting contours and curves.



# LUX ELEMENTS – WETROOM SOLUTION

Secure. Fast. Individual.

## The wetroom solution system

LUX ELEMENTS®  
Wall and floor panels

LUX ELEMENTS®  
Benches

LUX ELEMENTS®  
Shower bases  
and drain system

LUX ELEMENTS®  
Curbs and Ramps

# Content



## The wetroom solution system

All components from a single source	8
Assembly and sealing	9

## Wall and floor panels

The universal construction panel – specifications	10
Processing – wall cladding on stud frames in wet and dry areas	12
Processing – floor protection in wet and dry areas	13

## Bath tub surrounds

Bath tub surrounds – specifications	14
Processing – Bath tub surrounds, e.g. TOP-TRU – corner installation	16

## Shower bases and drain system

Point and linear drainage – specifications	18
Sealing of the shower area – specifications	23
Processing – Shower base, floor drain assembly	24
Processing – Curbless shower base	26
Processing – sealing of the shower area with sealing filler and sealing tape	28
Processing – sealing of the shower area with mounting adhesive and sealing tape	29

## Benches - Niches - Curbs and Ramps

Specifications	30
Processing – bench seat corner floating	32
Processing – niche with two shelves	34
Processing – curb or ramp	36

## Washstands

Washstands in “floating” design – specifications	38
Processing – Washstands, e.g. LAVADO-FLOAT Z	40

## Processing tips

42

## The wetroom solution system

### All components from a single source

#### ■ Wall and floor panels

**LUX ELEMENTS®-ELEMENT-EL ...**  
The construction panels are available in various dimensions

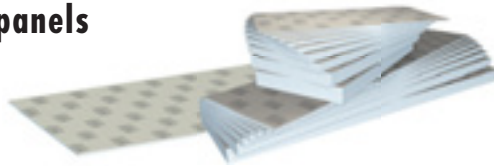

#### ■ Bath surrounds

**LUX ELEMENTS®-TOP-TR ...**  
Cladding for standard steel and plastic bath tubs. Ready for tiling, suitable for all installation situations

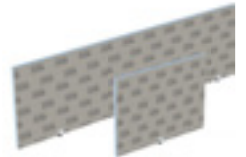

#### ■ Shower bases and drain system



**LUX ELEMENTS®-TUB-... – point drainage**  
Tileable shower bases with sealed central or off-centre point drainage and 4-sided slope in many shapes and sizes, e.g.:

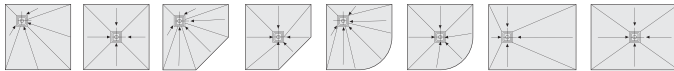

**LUX ELEMENTS®-TUB-LINE ... – linear drainage**  
Tileable shower bases, square or rectangular, with 1 or 4-sided slope with sealed-in floor channel drain in various sizes, e.g.:

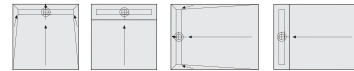

#### ■ Benches



**LUX ELEMENTS®-RELAX-BA-CO ...**  
bench seat corner, solid and bench seat corner, floating, with assembling kit, in two widths

**LUX ELEMENTS®-RELAX-BA-SOLO-G ...**  
bench form SOLO, straight, in two widths

#### ■ Niches

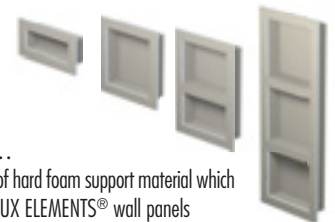

**LUX ELEMENTS®-RELAX-NI ...**  
four prefabricated niches made of hard foam support material which can be ideally combined with LUX ELEMENTS® wall panels

#### ■ Curbs and Ramps

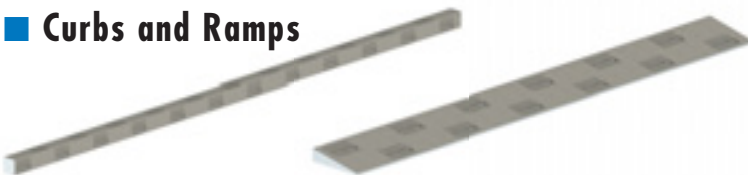

**LUX ELEMENTS®-RELAX-CU-F ...**  
two standard curbs in different lengths as a water barrier

**LUX ELEMENTS®-RELAX-RP ...**  
two standard ramps in different gradient, for creating a barrier-free shower area

#### ■ Washstands

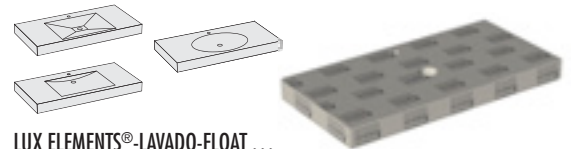

**LUX ELEMENTS®-LAVADO-FLOAT ...**  
four model variants with or without recess with a "floating design", made of hard foam support material for individual tiling

#### ■ Mounting accessories



**LUX ELEMENTS®-COL-MK**  
Mounting adhesive



Primer



Fixing adhesive



**LUX ELEMENTS®-DRY-DB...**  
Sealing tapes



**LUX ELEMENTS®-DRY-ASK**  
Sealing filler



**LUX ELEMENTS®-ARM ...**  
Reinforcement transitions

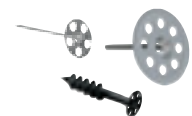

**LUX ELEMENTS®-FIX ...**  
Fixings: Screws, washer, and plugs



# The wetroom solution system

## Assembly and sealing

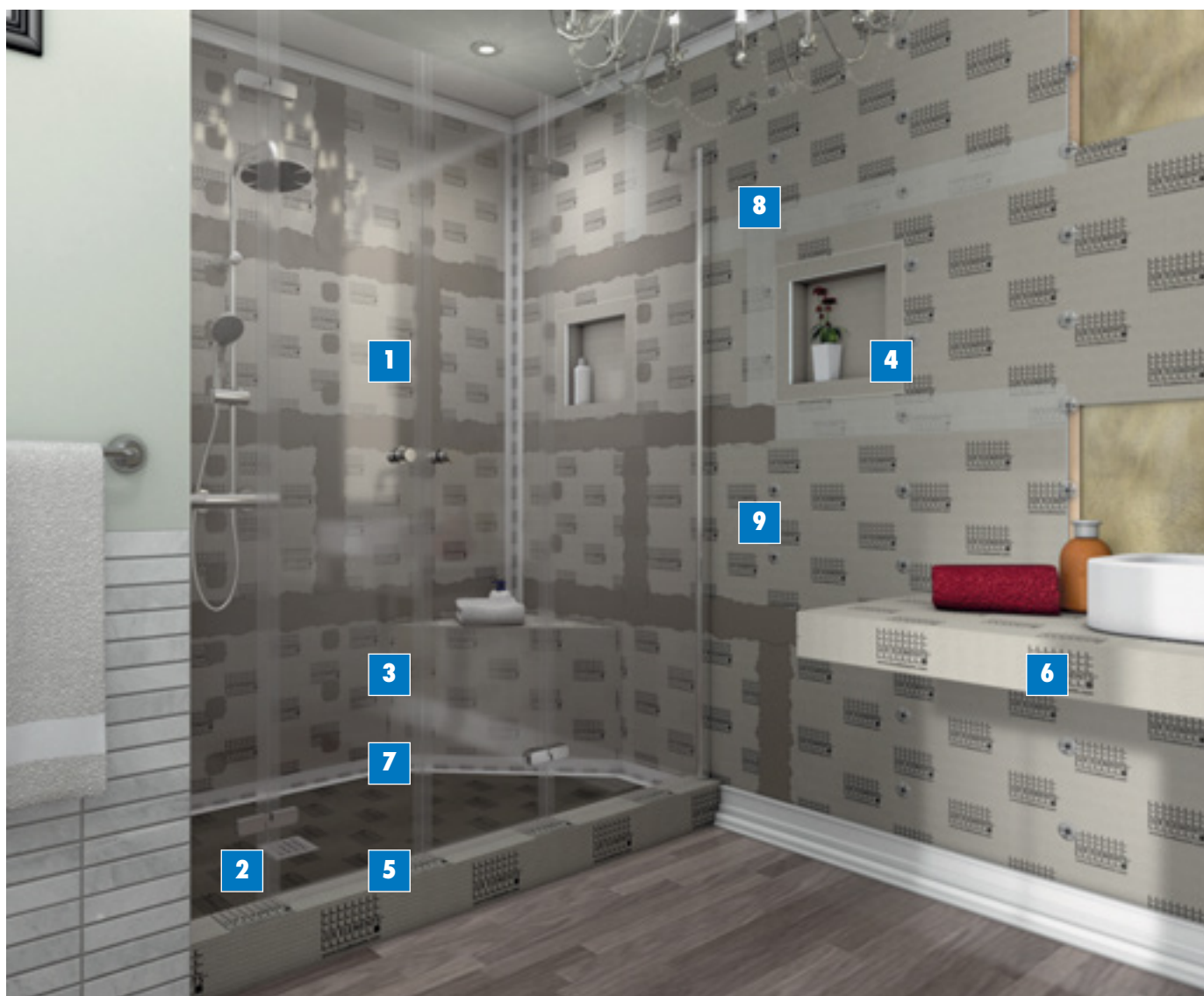

**1 Wall and floor panels**  
with mounting adhesive

**2 Shower base and drain system**

**3 Bench**

**4 Niche**

**5 Curb or Ramp**

**6 Washstand**

### Mounting accessories:

**7 Sealing tape**  
with sealing filler or mounting adhesive

**8 Reinforcement transitions**

**9 Fastening set**  
with screw and washer for installation on supports

# Wall and floor panels

## The universal construction panel

Wall cladding on stud frames



LUX ELEMENTS®-ELEMENT-EL is a support element made of polystyrene hard foam with mortar coating and glass fibre fabric on both sides. It is a more suitable material for wetroom construction than plasterboard and wood.

### Application areas:

- **Wall levelling**  
4 – 6 mm · 3/16 – 1/4"
- **Wall cladding on stud frames in wet and dry areas**  
12 and 20 mm · 1/2 and 13/16"
- **Floor protection in wet and dry areas**  
12 and 20 mm · 1/2 and 13/16"
- **Floor leveling with shower base flush with the floor**  
12 and 20 mm · 1/2 and 13/16"
- **Installation on dots**  
from 30 mm · 1 3/16"

Floor protection

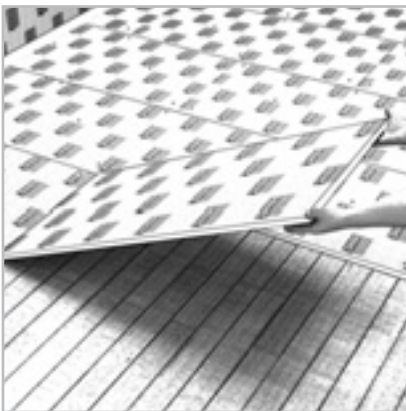

Floor leveling with shower base flush with the floor

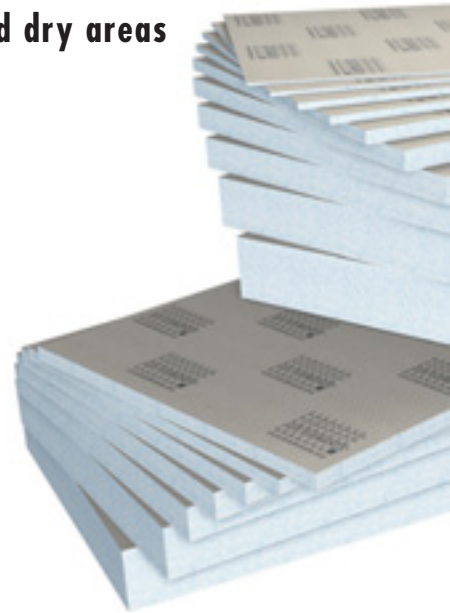
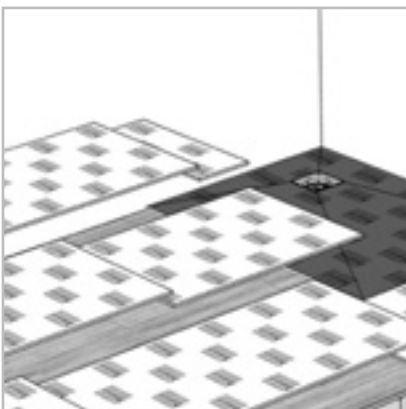

Thicker thicknesses from 30 to 100 mm · 1 3/16 to 3 15/16" are suitable for cladding, construction and insulating



For further information, please refer to our documents. Data sheets, test certificates and processing instructions can be downloaded from [www.luxelements.ca](http://www.luxelements.ca)



ASME A112.18.2 / CSA B 125.2  
The panels are cUPC certified as a part of a kit listed under the IAPMO file 8712.

Ready for tiling, easy-to-use and versatile in everyday practice. Using ELEMENT to make substrates for thin-bed laying is just as problem-free as any of the processes involving design, construction, cladding, insulation and sealing.

# LUX ELEMENTS – WETROOM SOLUTION

Secure. Fast. Individual.

## Wall and floor panels

### Specifications

Article-name	Dimensions length x width x thickness
ELEMENT-EL Baby 4	1250 x 600 x 4 mm 4' x 2' x 3/16"
ELEMENT-EL Baby 6	1250 x 600 x 6 mm 4' x 2' x 1/4"
ELEMENT-EL Baby 10	1250 x 600 x 10 mm 4' x 2' x 3/8"
ELEMENT-EL Baby 12	1250 x 600 x 12 mm 4' x 2' x 1/2"
ELEMENT-EL Baby 20	1250 x 600 x 20 mm 4' x 2' x 13/16"
ELEMENT-EL Baby 30	1250 x 600 x 30 mm 4' x 2' x 1 3/16"
ELEMENT-EL Baby 40	1250 x 600 x 40 mm 4' x 2' x 1 9/16"
ELEMENT-EL Baby 50	1250 x 600 x 50 mm 4' x 2' x 1 15/16"
ELEMENT-EL Baby 80	1250 x 600 x 80 mm 4' x 2' x 3 1/8"
ELEMENT-EL Baby 100	1250 x 600 x 100 mm 4' x 2' x 3 15/16"

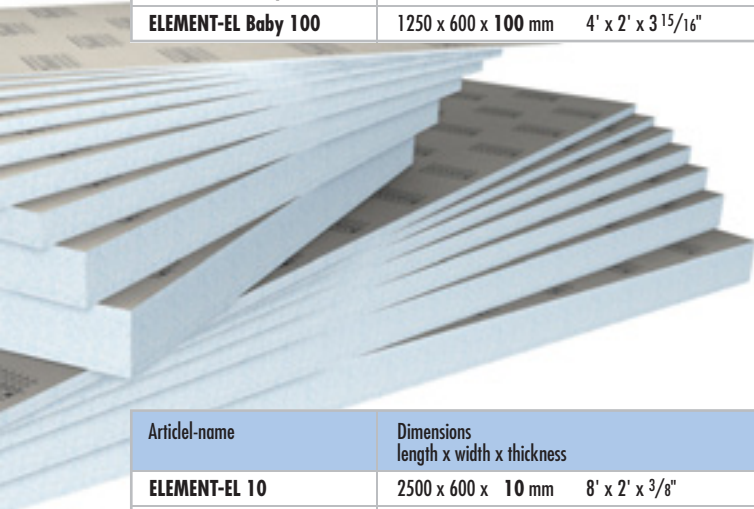

Article-name	Dimensions length x width x thickness
ELEMENT-EL 10	2500 x 600 x 10 mm 8' x 2' x 3/8"
ELEMENT-EL 12	2500 x 600 x 12 mm 8' x 2' x 1/2"
ELEMENT-EL 20	2500 x 600 x 20 mm 8' x 2' x 13/16"
ELEMENT-EL 30	2500 x 600 x 30 mm 8' x 2' x 1 3/16"
ELEMENT-EL 40	2500 x 600 x 40 mm 8' x 2' x 1 9/16"
ELEMENT-EL 50	2500 x 600 x 50 mm 8' x 2' x 1 15/16"
ELEMENT-EL 80	2500 x 600 x 80 mm 8' x 2' x 3 1/8"
ELEMENT-EL 100	2500 x 600 x 100 mm 8' x 2' x 3 15/16"
ELEMENT-EL 1524/900 12	1524 x 900 x 12 mm 5' x 3' x 1/2"

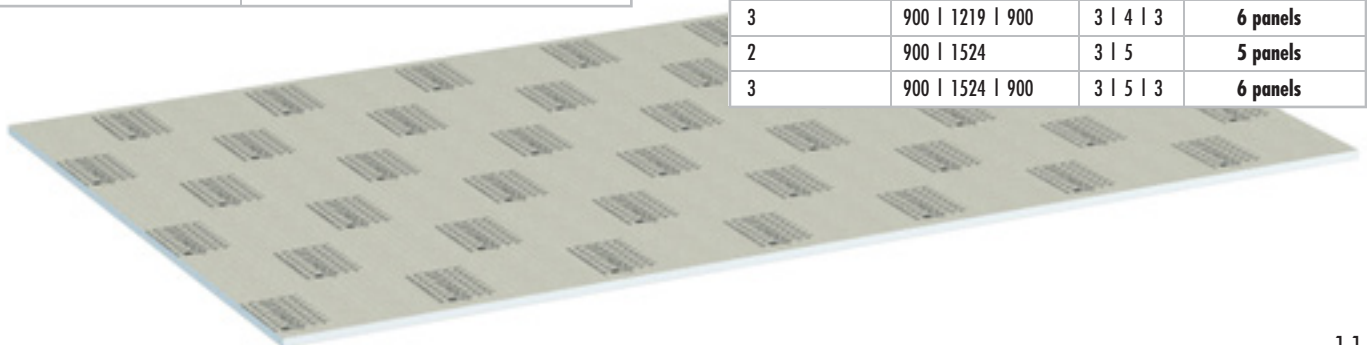

### ■ Bundle offer: Wall KIT

The KIT includes the matching processing materials for the creation of a safe wall-substrate.

#### LUX ELEMENTS®-ELEMENT-EL WALL-KIT

Mounting set for wall-sizes 900 x 900 mm up to 1250 x 1800 mm - 3' x 3' up to 4' x 6', consisting of:

- 2 cartridges mounting adhesive COL-MK,
- 10 m - 33' reinforcement fabric ARM-100 SK,
- 3 x 50 fastening sets with screw and washer FIX-SB 45S35

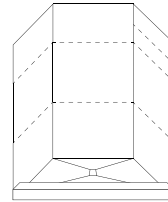

You can determine the number of construction panels required for your project by referring to the following table or by asking our customer consultants.

Number of walls height: 2438 mm - 8'	Wall width		Required wall panel 1524 x 900 mm - 5 x 3'
	mm	ft	
2	900   900	3   3	<b>4 panels</b>
2 1/2	900   900   900	3   3   3	<b>5 panels</b>
3	900   900   900	3   3   3	<b>5 panels</b>
2	1219   1219	4   4	<b>5 panels</b>
2 1/2	1219   1219   1219	4   4   4	<b>7 panels</b>
3	1219   1219	4   4   4	<b>8 panels</b>
2	1524   1524	5   5	<b>6 panels</b>
2 1/2	1524   1524   1524	5   5   5	<b>7 panels</b>
3	1524   1524	5   5   5	<b>8 panels</b>
2	900   1219	3   4	<b>5 panels</b>
3	900   1219   900	3   4   3	<b>6 panels</b>
2	900   1524	3   5	<b>5 panels</b>
3	900   1524   900	3   5   3	<b>6 panels</b>

# LUX ELEMENTS – WETROOM SOLUTION

Secure. Fast. Individual.

## ■ Wall cladding – on stud frames in wet and dry areas

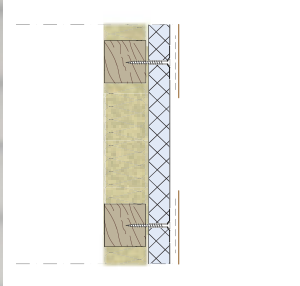

### PREPARATION

The spacing of the laths must be aligned according to national directives/approvals. The stud frame forms the substructure.



1a

Cut the panels to size in such a way that the vertical seam lies centrally on the brace.



1b

The first ELEMENT is aligned vertically and horizontally transverse to the profiles and screwed on with FIX-S 35 + suitable screws.



2

The ELEMENT construction panels are laid in groups; diagonal joints are not allowed. The ELEMENT construction panels are glued together with COL-MK. Apply the adhesive to the plate edges as an uninterrupted strand.



3

Then push the next ELEMENT into the adhesive layer.

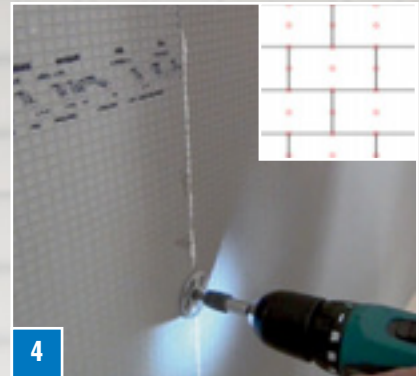

4

After aligning, screw in with FIX-S 35 + a suitable screw. Screwing according to the indicated intervals.

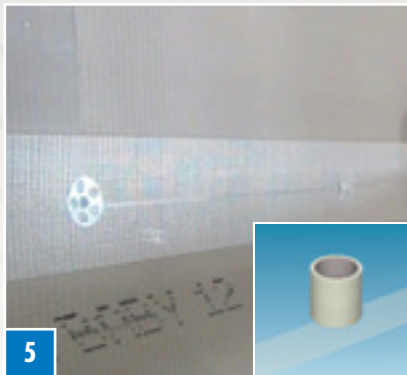

5

All element joints must be reinforced with glass fibre reinforcement strips ARM-100 SK.



6

Level out the reinforced element joints and the heads of the mounting elements with fixing adhesive.



7

The surface is now ready for tiling or plastering. Further requirements (e.g. sealing for wet loads) must be taken into consideration in accordance with national directives.

# Wall and floor panels – Processing

Installation video on [www.m.luxelements.com](http://www.m.luxelements.com)  
or visit our new Youtube-Channel on  
[www.youtube.com/user/luxelements.com](http://www.youtube.com/user/luxelements.com)

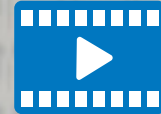

## ■ Floor protection – in wet and dry areas

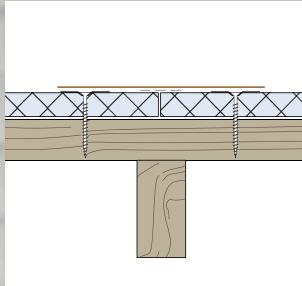

### PREPARATION

The substrate must be load-bearing and vibration-free. Loose boards must be re-screwed and rotten boards no longer suitable for bearing loads must be replaced. Irregularities must be compensated using levelling filler. Paint the entire floor area with wood floor primer.

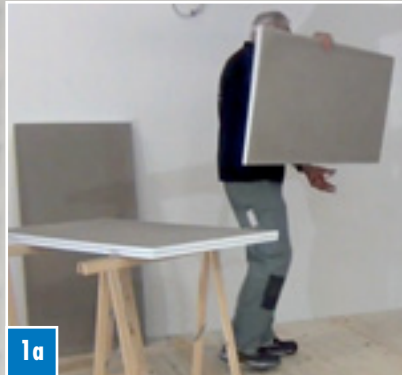

1a

The shorter Baby construction panels from ELEMENT-EL Baby 10 are suitable for this application.

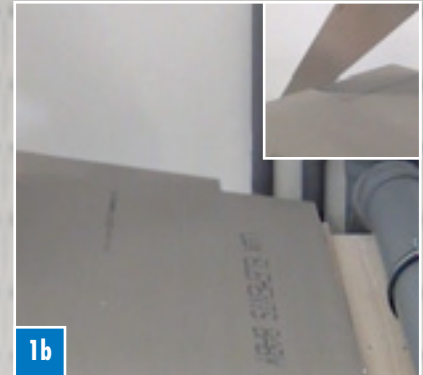

1b

If applicable, mark and saw out cutouts for pipes or similar elements.

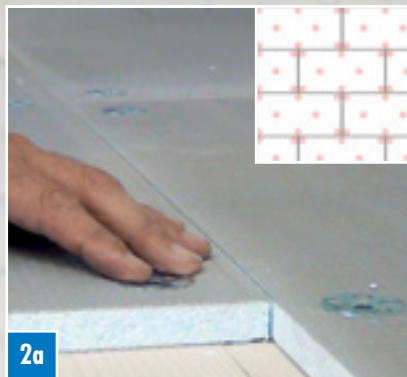

2a

Lay ELEMENT-EL from EL Baby 10 in bond, cross joints are not permissible. Screwing according to the indicated intervals.

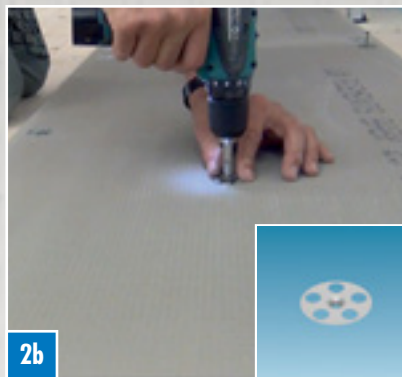

2b

Screw spacing max. 300/300 mm · 11/11". Select screws according to the substrate and panel thickness using FIX-S 35 fastening washers.



3

Reinforce ELEMENT joints with ARM-100 SK ...



4a

... and level out with fixing adhesive.



4b

Also level out the bolted connections with fixing adhesive.

The surface is now ready for tiling or plastering.

!

We recommend a tile size of 50 x 50 mm · 2 x 2". A total pressure load of 0.1 N/mm<sup>2</sup> · 14.5 psi must not be exceeded.

When using for higher loads such as transport traffic, rack systems etc., please contact the LUX ELEMENTS technical department.

## Bath tub surrounds

### Specifications

#### ■ Surrounds for smooth and flush bath cladding

LUX ELEMENTS®-TOP-TRS ...

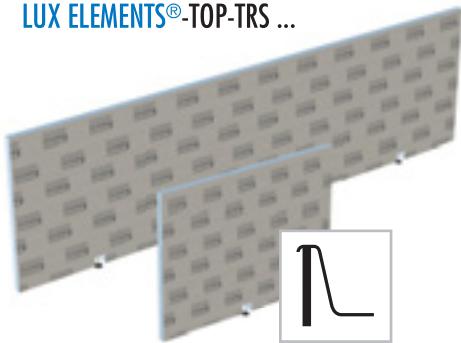

##### TOP-TRS 1685 S

Surround for bath tubs up to 1700 mm · 66 15/16" dimensions:  
1685 x 600 x 30 mm · 66 5/16" x 23 5/8" x 1 3/16"

##### TOP-TRS 1860 S

Surround for bath tubs up to 1900 mm · 74 13/16" dimensions:  
1860 x 600 x 30 mm · 74 1/4" x 23 5/8" x 1 3/16"

##### TOP-TRS 800 S

Surround for bath tub head end dimensions:  
800 x 600 x 30 mm · 31 1/2" x 23 5/8" x 1 3/16"

##### TOP-TRS 1785 S

Surround for bath tubs up to 1800 mm · 70 7/8" dimensions:  
1785 x 600 x 30 mm · 70 1/4" x 23 5/8" x 1 3/16"

##### TOP-TRS 2100 S

Surround for bath tubs up to 2100 mm · 82 11/16" or tubs with foot-end shelving dimensions:  
2100 x 600 x 30 mm · 82 11/16" x 23 5/8" x 1 3/16"

##### TOP-TRS 900 S

Surround for bath tub head end dimensions:  
900 x 600 x 30 mm · 35 7/16" x 23 5/8" x 1 3/16"

#### ■ Surrounds with footboard

LUX ELEMENTS®-TOP-TRU...

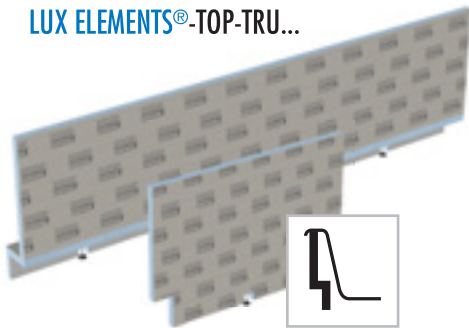

##### TOP-TRU 2100 S

Surround with footboard for bath tubs up to 2100 mm · 82 11/16" or bath tubs with foot-end shelving dimensions:  
2100 x 600 x 30 mm · 82 11/16" x 23 5/8" x 1 3/16"

##### TOP-TRU 900 S

Surround for bath tub head end dimensions:  
900 x 600 x 30 mm · 35 7/16" x 23 5/8" x 1 3/16"

#### ■ Surrounds with ledge

LUX ELEMENTS®-TOP-TRV ...

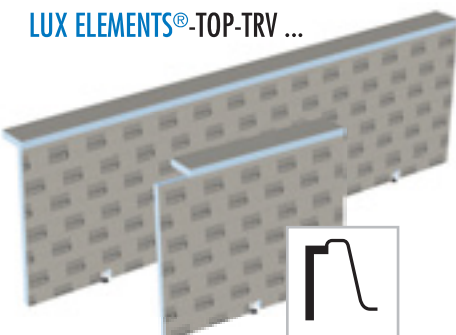

##### TOP-TRV 2100 S

Surround with ledge for bath tubs up to 2100 mm · 82 11/16" dimensions:  
2100 x 580 x 30 mm · 82 11/16" x 22 13/16" x 1 3/16"

##### TOP-TRV 900 li S

Surround with ledge for left hand bath tub head end dimensions:  
900 x 580 x 30 mm · 35 7/16" x 22 13/16" x 1 3/16"

##### TOP-TRV 900 re S

Surround with ledge for right hand bath tub head end dimensions:  
900 x 580 x 30 mm · 35 7/16" x 22 13/16" x 1 3/16"

NOTE: Bath tub surrounds for standard rectangular tubs are not available as kits. Depending on the installation situation as many as 4 elements are needed.

## ■ Installation situation

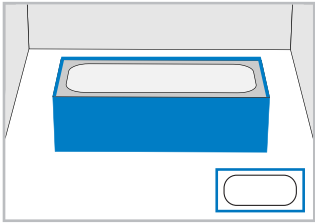

Free-standing

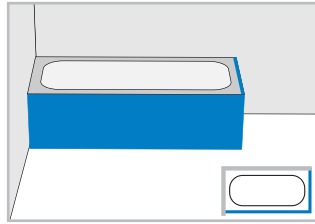

Corner installation

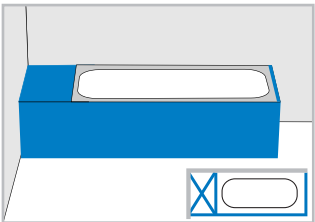

Installation with shelf

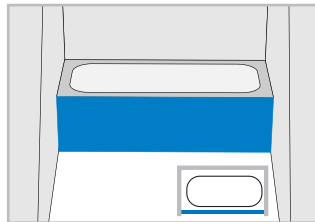

Niche installation

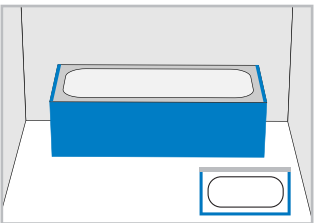

3-sided installation

## ■ Inspection options for TOP-TR...

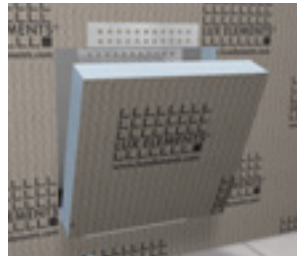

Two solutions are available to choose from for maintenance and repair.

### LUX ELEMENTS®-MONT-TOP-REVR

Mounting aid for maintenance openings for bath tubs consisting of 2 parts for top and bottom



### LUX ELEMENTS®-TOP-REVR-TR

Recessed, removable maintenance opening integrated into the front or side wall, for all TRV model design variants



For further information, please refer to our documents. Data sheets, test certificates and processing instructions can be downloaded from [www.luxelements.ca](http://www.luxelements.ca)

## ■ Mounting accessories



### LUX ELEMENTS®-TOP-AN

Mounting aid for cladding elements:

- 2 rabbets EL 50 with
- 2 pieces FIX-FID 110 each



### LUX ELEMENTS®-TOP-KIT

Mounting kit for bath tub surrounds:

- 4 pieces FIX-FID 110,
- 10 pieces FIX-SD 80
- 1 cartridge COL-MK

## ■ Additional material required:

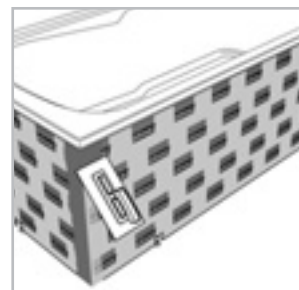

fixing adhesive

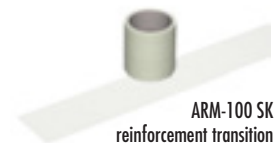

ARM-100 SK reinforcement transition

# LUX ELEMENTS – WETROOM SOLUTION

Secure. Fast. Individual.

## ■ Bath tub surrounds – with prefabricated surrounds, e.g. TOP-TRU – corner installation

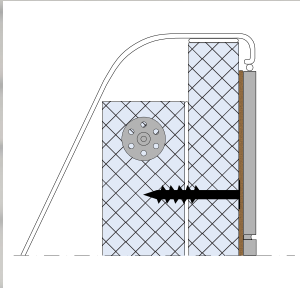

### PREPARATION

The bath tub is positioned and aligned by means of the tub legs, and the connections are professionally mounted. Wall fittings are required for the installation of the head and side claddings.



1a

Take into consideration the thickness of the fittings and the added measurement of the tiling when positioning the wall fittings.



1b

The fitting has to be set back from the bath tub edge.

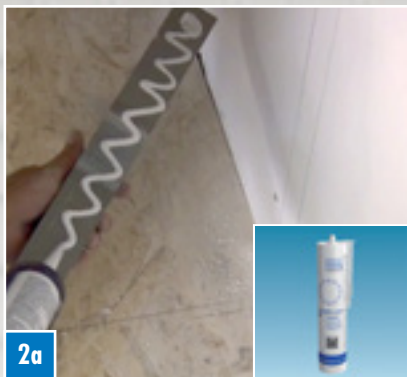

2a

Apply the COL-MK mounting adhesive to the wall fittings in a serpentine pattern, stick on the fittings...

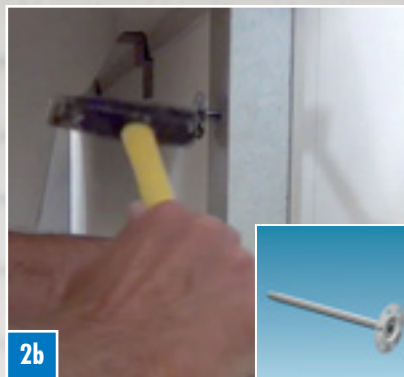

2b

...and then secure using FIX-FID 110 hammer fix plugs.

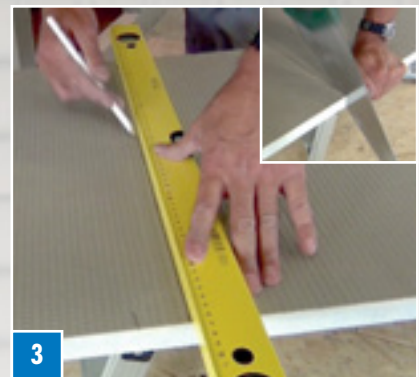

3

Cut the head element TOP-TRS with a saw, setting it back from the bath tub edge to allow for the element and tile thickness.



4a

Apply the adhesive COL-MK to the face end of the wall fitting ...



4b

... and the top edge of the head element.



4c

Push the head element firmly under the bath tub edge and against the end stop.



# Bath tub surrounds – Processing

Installation video on [www.m.luxelements.com](http://www.m.luxelements.com)  
or visit our new Youtube-Channel on  
[www.youtube.com/user/luxelements.com](http://www.youtube.com/user/luxelements.com)

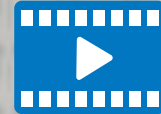

4d

Use the locking screw to regulate the height of the cladding.



4e

Screw two screw plugs FIX-SD 80 into the wall fitting through the head element.  
TIP: Pre-pierce dowel holes using a cross slot screwdriver.



5a



5b

Cut the side element to size using a saw.



6a

Apply the Adhesive COL-MK to the face end of the head element and the top edge of the side element TOP-TRS

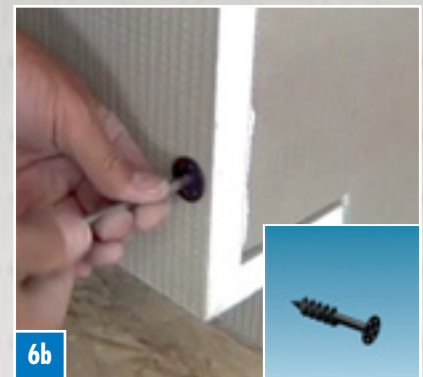

6b

... and connect them with screw plugs FIX-SD 80 (using the method described in Item 4b to 4e).



7

The cladding joints must be reinforced with glass fibre reinforcement strips ARM-100 SK.



8

Level out the reinforced joints with fixing adhesive. The surface is now ready for tiling or plastering.

## Shower bases and drain system

### Specifications

#### ■ Point and linear drainage – the principle

##### LUX ELEMENTS®-TUB ...

Tileable shower bases, square or rectangular, with sealed central or off-centre **point drainage** and 4-sided slope in many shapes and sizes.

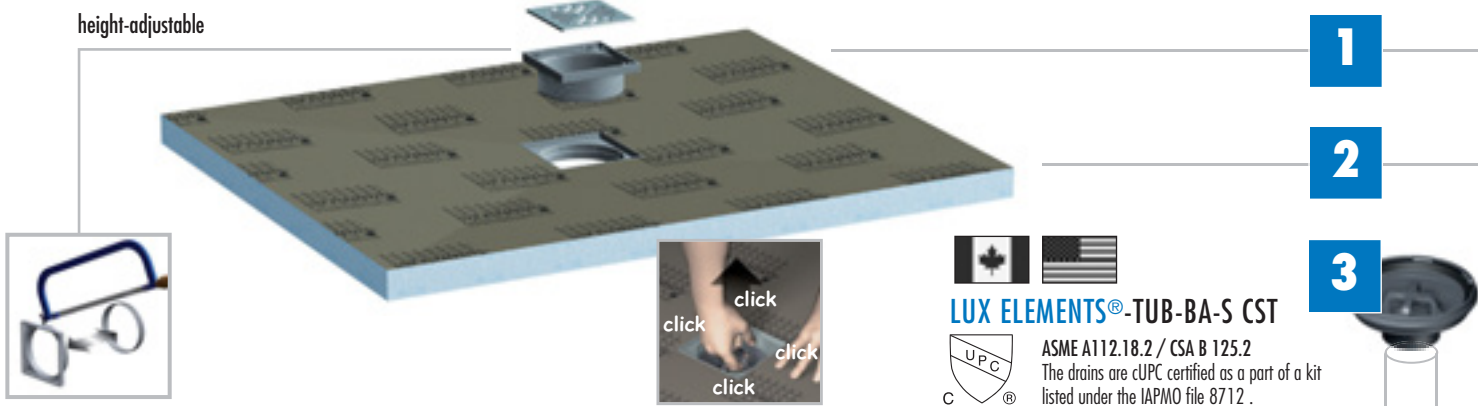
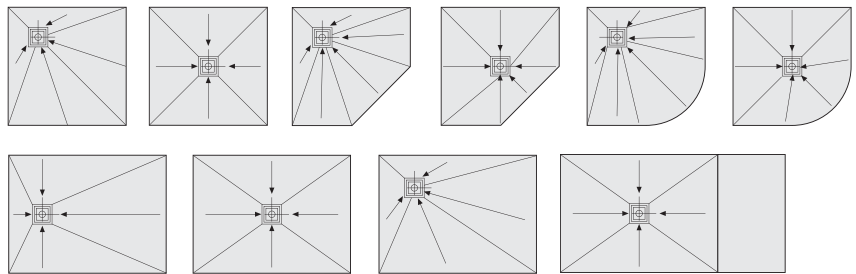

##### LUX ELEMENTS®- TUB-RA-...

Height-adjustable grate fitting frame made of ABS to suit tile thickness and drain grate.



#### Acceptable tile thicknesses (tile + adhesive)

- for the shower base at least 5 mm · 3/16" (RA-DA, RA-DC, RA-DM, RA-DL, RA-DS, RA-S)
- for the shower base at least 5 mm · 3/16", for the tileable cover = 8 mm · 5/16" (RA-DV)
- for the shower base at least 14 mm · 9/16", for the tileable cover = 11 mm · 7/16" (RA-DF)

**1** Two drainage versions – Point drainage with height-adjustable grate fitting frame and standard or design grate, or **linear drainage** with reversible cover rail for two surface variants, tiled or stainless steel, height-adjustable.

**2** Shower base element – Equipped with factory-fitted seal and slope as well as sealed-in grate or channel fitting frame for high security.

**3** Floor drain support – Fits all LUX ELEMENTS® shower base elements with point or linear drainage. Secure and fast installation by means of click system, cUPC certified.

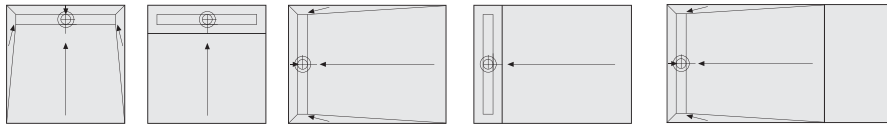

## LUX ELEMENTS®-TUB-LINE ...

Tileable shower bases, square or rectangular, with 4-sided or single sided slope with sealed-in floor channel drain in various sizes.

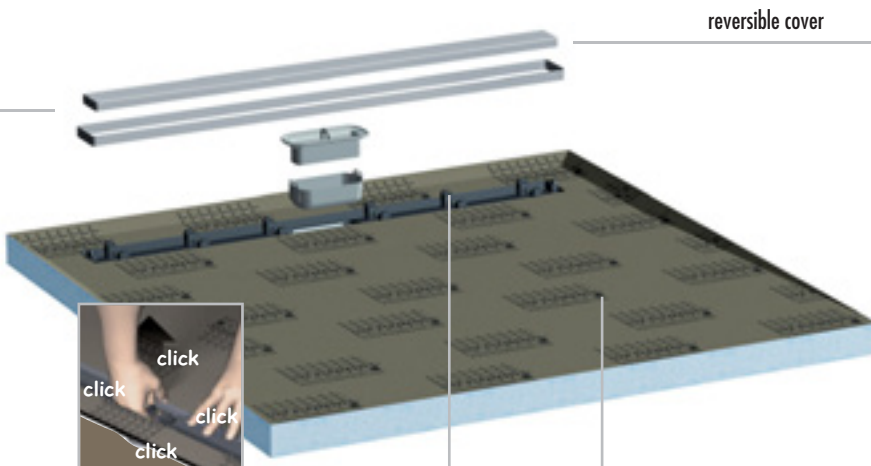

reversible cover



height-adjustable

2 gradient variants

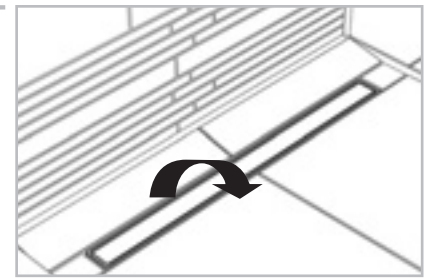

cover rail tiled

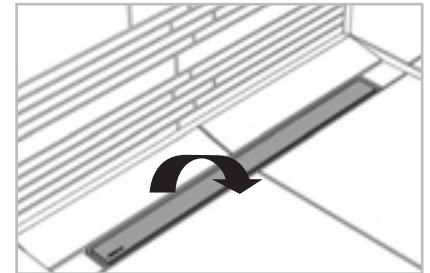

cover rail turned, brushed stainless steel

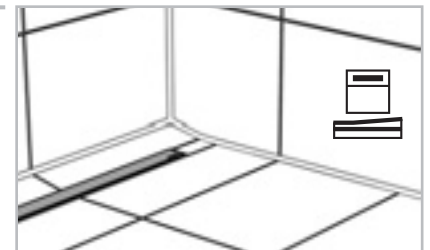

single-sided gradient



4-sided gradient

Separately provided **adapters** that can be cut as required enable **height-adjustability** of the channel for surface covering thicknesses from 5 to 17 mm · 3/16" to 11/16".

Acceptable tile thicknesses (tile + adhesive)

- for the shower base minimum 5 mm · 3/16", maximum 17 mm · 11/16", for the tileable stainless steel channel cover = 12 mm · 1/2"



For further information, please refer to our documents. Data sheets, test certificates and processing instructions can be downloaded from [www.luxelements.ca](http://www.luxelements.ca)

# Shower bases and drain system

## Specifications

### ■ Shower bases for universal applications

Hard foam shower base elements for concrete substrates or wooden sub-constructions.

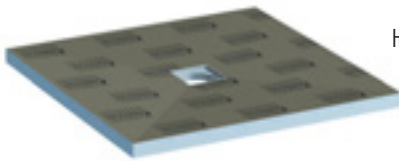

**Point drainage**  
Hard foam shower base elements, with integrated and sealed floor drain support frame 135 x 135 mm · 5 x 5".

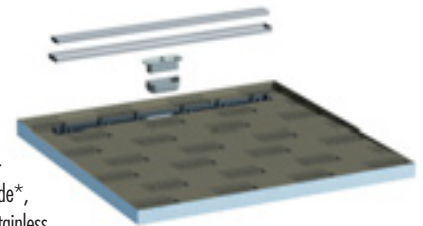

**Linear drainage**  
Hard foam shower base elements, with integrated and sealed floor channel drain on shorter side\*, with cover rail and tiling aid made of brushed stainless steel, cover rail tileable on the rear side (see page 19), with odour trap, height-adjustable with height adapter from 5 – 17 mm · 3/16 – 11/16".

### LUX ELEMENTS®-TUB ...

Drain position: in the corner or off-centre

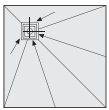

#### TUB-EQ ...

**Square**, standard dimensions up to 1500 x 1500 x 30/45 mm · 59 1/16 x 59 1/16 x 1 3/16/1 3/4".

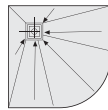

#### TUB-EF ...

**Pentagonal**, standard dimensions up to 1000 x 1000 x 30/45 mm · 39 3/8" x 39 3/8" x 1 3/16/1 3/4".

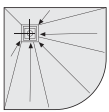

#### TUB-EK ...

**Quadrant**, standard dimensions up to 1000 x 1000 x 30/45 mm · 39 3/8" x 39 3/8" x 1 3/16/1 3/4".

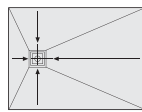

#### TUB-ER ...

**Rectangular**, standard dimensions up to 1600 x 900 x 30/45 mm · 63" x 35 3/16" x 1 3/16/1 3/4".

Drain position: in the centre

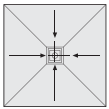

#### TUB-MQ ...

**Square**, standard dimensions up to 1500 x 1500 x 30/45 mm · 59 1/16 x 59 1/16 x 1 3/16/1 3/4".

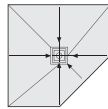

#### TUB-MF ...

**Pentagonal**, standard dimensions up to 1000 x 1000 x 30/45 mm · 39 3/8" x 39 3/8" x 1 3/16/1 3/4".

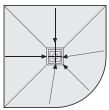

#### TUB-MK ...

**Quadrant**, standard dimensions up to 1000 x 1000 x 30/45 mm · 39 3/8" x 39 3/8" x 1 3/16/1 3/4".

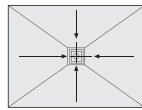

#### TUB-MR ...

**Rectangular**, standard dimensions up to 1600 x 900 x 30/45 mm · 63" x 35 3/16" x 1 3/16/1 3/4".

### LUX ELEMENTS®-TUB-LINE ...

\*Floor channel drain: 750 x 70 mm · 29 1/2" x 2 3/4"

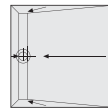
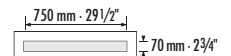

#### TUB-LINE Q4 ...

**Square**, 4-sided slope, standard dimensions 900 x 900 x 30/45 mm · 35 7/16" x 35 7/16" x 1 3/16/1 3/4".

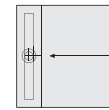

#### TUB-LINE Q1 ...

**Square**, 1-sided slope, standard dimensions 900 x 900 x 30/45 mm · 35 7/16" x 35 7/16" x 1 3/16/1 3/4".

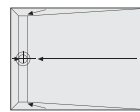

#### TUB-LINE R4 ...

**Rectangular**, 4-sided slope, standard dimensions up to 1600 x 900 x 30/45 mm · 63" x 35 3/16" x 1 3/16/1 3/4".

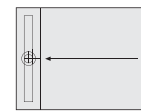

#### TUB-LINE R1 ...

**Rectangular**, 1-sided slope, standard dimensions up to 1600 x 900 x 30/45 mm · 63" x 35 3/16" x 1 3/16/1 3/4".

\*Floor channel drain: 850 x 70 mm · 33 7/16" x 2 3/4"

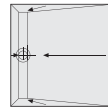
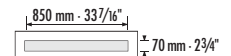

#### TUB-LINE Q4 ...

**Square**, 4-sided slope, standard dimensions up to 1200 x 1200 x 30/45 mm · 47 1/4" x 47 1/4" x 1 3/16/1 3/4".

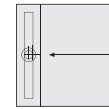

#### TUB-LINE Q1 ...

**Square**, 1-sided slope, standard dimensions up to 1200 x 1200 x 30/45 mm · 47 1/4" x 47 1/4" x 1 3/16/1 3/4".

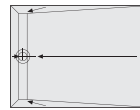

#### TUB-LINE R4 ...

**Rectangular**, 4-sided slope, standard dimensions 1200 x 1000 x 30/45 mm · 47 1/4" x 39 3/8" x 1 3/16/1 3/4".

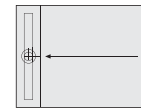

#### TUB-LINE R1 ...

**Rectangular**, 1-sided slope, standard dimensions 1200 x 1000 x 30/45 mm · 47 1/4" x 39 3/8" x 1 3/16/1 3/4".

## ■ Shower drain elements for flexible applications

If a screed floor with a slope already exists, this is the ideal solution for the secure installation of a shower.



### Point drainage

Hard foam shower drain element, 300 x 300 x 30 mm · 11 13/16" x 11 13/16" x 1 3/16", with integrated floor drain support frame 135 x 135 mm · 5 x 5", loose sealing sleeve 400 x 400 mm · 15 3/4" x 15 3/4" and substrate element TUB-UMQ 300 x 300 x 55 mm · 11 13/16" x 11 13/16" x 2 3/16".

### LUX ELEMENTS®-TUB-MQ-SET 300

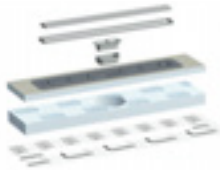

### Linear drainage

Floor channel drain with cover rail and tiling aid made of brushed stainless steel, cover rail tileable on the rear side, with odour trap, height-adjustable with height adaptor from 5 – 17 mm · 3/16 – 11/16", integrated in hard foam support element, including substrate element, including sealing sleeve.

### LUX ELEMENTS®-TUB-LINE RT ...



### TUB-LINE RT 900/200 (650)

with floor channel drain 650 x 70 mm · 25 9/16" x 2 3/4", standard dimensions 900 x 200 x 30 mm · 35 7/16" x 7 7/8" x 1 3/16".

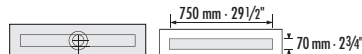

### TUB-LINE RT 900/200 (750)

with floor channel drain 750 x 70 mm · 29 1/2" x 2 3/4", standard dimensions 900 x 200 x 30 mm · 35 7/16" x 7 7/8" x 1 3/16".



### TUB-LINE RT 1200/200 (850)

with floor channel drain 850 x 70 mm · 33 7/16" x 2 3/4", standard dimensions 1200 x 200 x 30 mm · 47 1/4" x 7 7/8" x 1 3/16".

## ■ Shower bases for the substitution of bath tubs

The dimensions of these shower bases correspond to the size of common bath tubs. Hence, an old tub is replaced simply and fast by a modern shower base.

### Point drainage

Hard foam shower base elements, with integrated and sealed floor drain support frame 135 x 135 mm · 5 x 5". Can be cut to length outside the shower area. Drain in the slope area in the centre.

shower area

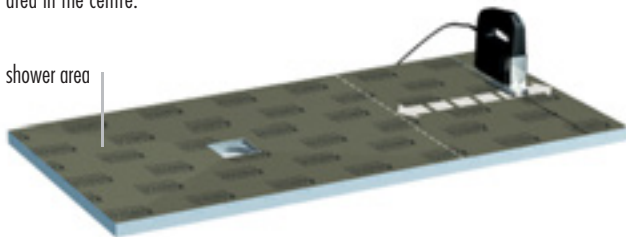

### LUX ELEMENTS®-TUB-BOL ...

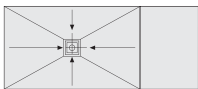

### TUB-BOL 1800/750

Rectangular, standard dimensions 1800 x 750 x 30/45 mm · 70 7/8" x 29 1/2" x 1 3/16/1 3/4".

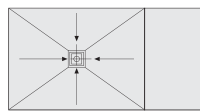

### TUB-BOL 1800/900

Rectangular, standard dimensions 1800 x 900 x 30/45 mm · 70 7/8" x 36 7/16" x 1 3/16/1 3/4".

### Linear drainage

Hard foam shower base element, with 4-sided gradient, with integrated and sealed floor channel drain 70 x 750 mm · 2 3/4 x 29 1/2" on shorter side. Cover rail brushed stainless steel or tileable on rear side, with odour trap, height-adjustable with height adapter from 5 – 17 mm · 3/16 – 11/16".

shower area

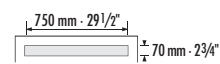
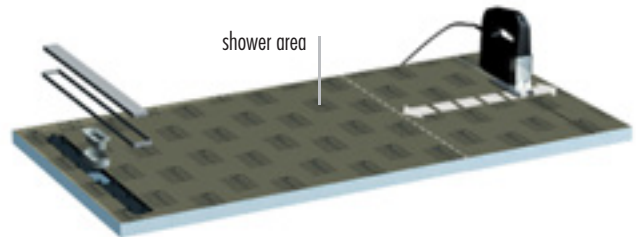

### LUX ELEMENTS®-TUB-LINE BOL 1800/900

Rectangular, standard dimensions 1800 x 900 x 30/45 mm · 70 7/8" x 36 7/16" x 1 3/16/1 3/4". Can be cut to length outside the shower area.

Note: the fittings are to be located in the shower area.

# Shower bases and drain system

## Specifications

### ■ Curbless shower bases

These particular flat products can be integrated optimally into existing wooden floors. A special reinforcement on the underside provides for high stability.

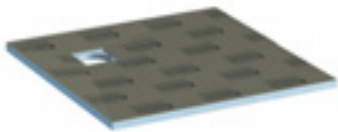

#### Point drainage

Hard foam shower base elements, with integrated and sealed-in floor drain fitting frame 135 x 135 mm · 5 x 5". Installation height 15/30 mm · 9/16/13/16".

#### LUX ELEMENTS®-TUB-H ...

Drain position: in the corner

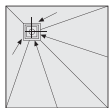

#### TUB-HEQ ...

Square, standard dimensions up to 1200 x 1200 x 15/30 mm · 47 1/4" x 47 1/4" x 9/16/13/16".

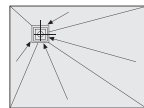

#### TUB-HER ...

Rectangular, standard dimensions up to 1600 x 900 x 15/30 mm · 63" x 35 3/16" x 9/16/13/16".

Drain position: in the centre

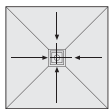

#### TUB-HMQ ...

Square, standard dimensions up to 1200 x 1200 x 15/30 mm · 47 1/4" x 47 1/4" x 9/16/13/16".

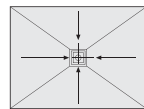

#### TUB-HMR ...

Rectangular, standard dimensions up to 1600 x 900 x 15/30 mm · 63" x 35 3/16" x 9/16/13/16".

... as a substitute for bath tubs

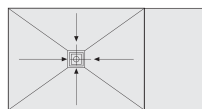

#### TUB-BOL 1800/900

Rectangular, standard dimensions 1800 x 900 x 15/30 mm · 70 7/8" x 36 7/16" x 9/16/13/16". Can be cut to length outside the shower area. Drain in the slope area in the centre.

#### Linear drainage

Hard foam shower base elements, 4-sided slope, with integrated and sealed floor channel drain on shorter side\*. Cover rail brushed stainless steel or tileable on rear side, with odour trap, height-adjustable with height adapter from 5 – 17 mm · 3/16 – 11/16".

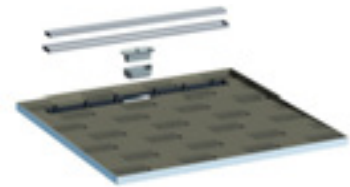

#### LUX ELEMENTS®-TUB-LINE H ...

\*Floor channel drain: 750 x 70 mm · 29 1/2" x 2 3/4"

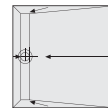
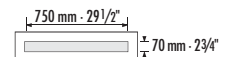

#### TUB-LINE HQ4 900

Square, standard dimensions 900 x 900 x 20/30 mm · 35 7/16" x 35 7/16" x 13/16/13/16".

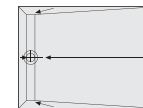

#### TUB-LINE HR4 ...

Rectangular, standard dimensions up to 1400 x 900 x 20/30 mm · 55 1/8" x 35 3/16" x 13/16/13/16".

\*Floor channel drain: 850 x 70 mm · 33 7/16" x 2 3/4"

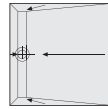
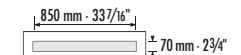

#### TUB-LINE Q4 ...

Square, standard dimensions up to 1200 x 1200 x 20/30 mm · 47 1/4" x 47 1/4" x 13/16/13/16".

... as a substitute for bath tubs

\*Floor channel drain: 750 x 70 mm · 29 1/2" x 2 3/4"

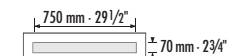

#### TUB-LINE H BOL 1800/900

Rectangular, standard dimensions 1800 x 900 x 20/30 mm · 70 7/8" x 36 7/16" x 13/16/13/16". Can be cut to length outside the shower area.

### ■ Special formats – TUB-PLUS

You can not find the right product? We also manufacture made-to-measure! Sizes, shapes, thicknesses etc., that do not correspond to the standard range can be enquired about separately at LUX ELEMENTS. After successful verification of the feasibility we will create a non binding offer. Once we receive your order, the order will be manufactured.



# Sealing of the shower area

## Specifications

### ■ Liquid sealing – the principle

The proven and tested system components are fully matched to the processing of the hard foam support elements. The specially developed accessories ensure trouble-free working and high processing reliability.

- TUB... – Shower base with factory-fitted seal
- ELEMENT-EL – water-resistant construction panel
- DRY-DB – sealing tape for connections
- DRY-ASK – sealing filler for sealing in the sealing tapes\*
- DRY-DBIE – sealing tape as a shaped part “inner corner”

\*NOTE: It is possible to create a sealing using LUX ELEMENTS®-COL-MK mounting adhesive instead of LUX ELEMENTS®-DRY-ASK.

### ■ Seals

For sealing in the shower area, a large selection of products from the product range LUX ELEMENTS®-DRY is available.

#### LUX ELEMENTS®-DRY-ASK

Sealing Filler, single-component, water-impermeable, crack-bridging and flexible sealing compound.

- 3,5 kg
- 20 kg



#### LUX ELEMENTS®-DRY-DB... sealing tapes

##### DRY-DB

Integrating sealing tape into wall/floor connections, extremely thin, tear-resistant special fleece for sealing. Suitable for all connection seals occurring in conjunction with DRY-ASK or COL-MK.

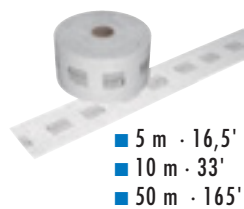

- 5 m · 16,5'
- 10 m · 33'
- 50 m · 165'

##### DRY-DBIE/DBAE

Sealing tape for inside and outside corners



### ■ Adhesives

For the processing of hard foam support elements.

#### LUX ELEMENTS®-COL-MK

Mounting adhesive, COL-MK is a moisture cross-linking, single component adhesive on an STP polymer basis for the gluing of LUX ELEMENTS® hard foam support elements.

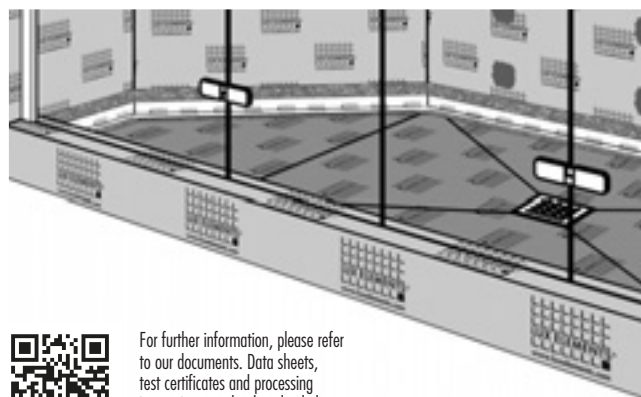

For further information, please refer to our documents. Data sheets, test certificates and processing instructions can be downloaded from [www.luxelements.ca](http://www.luxelements.ca)

### ■ Bundle offer: TUB-KITs

#### LUX ELEMENTS®-TUB-KIT CA A

Mounting kit for shower bases consisting of:

- 1 x floor drain support Canadian Standard for point or linear drainage TUB-BA-S CST,
- 1 x TUB-GEL, lubricant
- 1 x 3,5 kg sealing filler DRY-ASK,
- 20 m · 66' sealing tape DRY-DB,
- 4 x DRY-DBIE



#### LUX ELEMENTS®-TUB-KIT CA

Mounting kit for shower bases consisting of:

- 1 x floor drain support Canadian Standard for point or linear drainage TUB-BA-S CST,
- 1 x TUB-GEL, lubricant
- 3 cartridges mounting adhesive COL-MK,
- 20 m · 66' sealing tape DRY-DB,
- 4 x DRY-DBIE
- 1 x Adhesive Spreader



### ■ Additional material required:



# LUX ELEMENTS – WETROOM SOLUTION

Secure. Fast. Individual.

## ■ Shower base – Installation upon wooden floor, floor drain assembly



### PREPARATION

PLEASE OBSERVE:  
do not engage the floor drain support to the shower base prior to installation!



1

Mark the LUX ELEMENTS TUB® shower tray position onto the floor. Carefully remove the TUB shower tray and store somewhere safe.



2

Determine the adapter piece to the existing drain pipe.



3

Cut off the marked part using a bow saw.



4a

Glue

Apply adhesive to the connecting piece and push it into the existing drain pipe.



4b

Glue

Apply adhesive to the adapter and position it on the connecting piece.



5

Sealing test: Check the leak tightness of the drain and pipe by filling with water.



6



Paint the entire floor area with wood floor primer. Leave to dry for at least 2 hours. Where the TUB shower tray will sit, spread fixing adhesive onto the floor and drag the notched adhesive trowel (6 – 8 mm · 1/4 – 5/16") across the surface.



7a

TUB-GEL

Smear some lubricant TUB-GEL (included) around the black rubber seal of the shower drain base.



# Shower bases and drain system – Processing

Installation video on [www.m.luxelements.com](http://www.m.luxelements.com)  
or visit our new Youtube-Channel on  
[www.youtube.com/user/luxelements.com](http://www.youtube.com/user/luxelements.com)

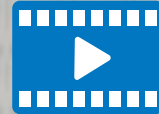

7b

Spread fixing adhesive onto the backside of the tray. Place the shower tray into position.

Put your fingers through the drain hole in the shower tray. Push down on the tray and ...

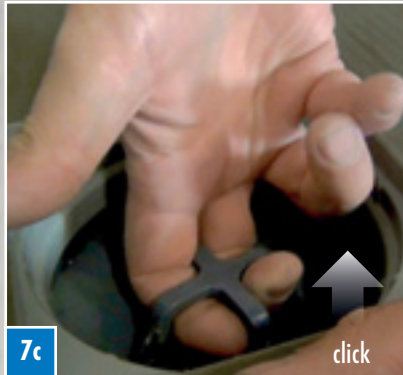

7c

... pull the shower drain base upwards until it clicks into place into the drain hole in the shower tray. After connecting the shower drain base and the shower tray correctly, the black rubber seal of the drain base should be invisible.

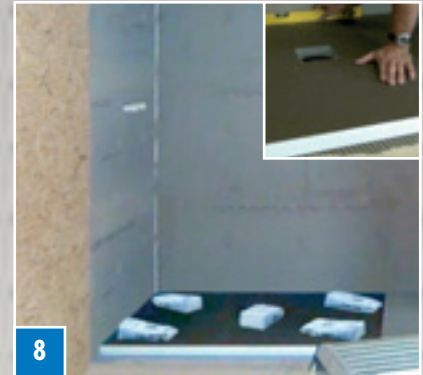

8

Press the shower base firmly into the thinset bed, ensuring that the installation is level and void free. Apply some weight equally and for at least 30 minutes.

## Shower base sealing with sealing tape and sealing filler, sealing tape and mounting adhesive or other liquid sealings



9a



9b

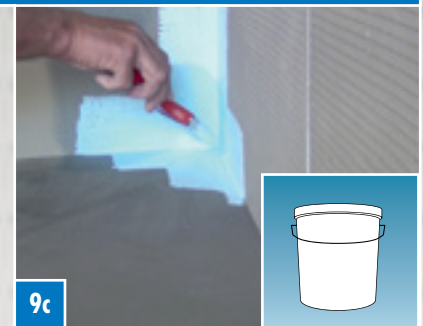

9c

For sealing the shower base we recommend the use of the tape sealer DRY-ASK, and as the fast variant the mounting adhesive COL-MK.

For other sealing options, please observe the national guidelines and release of the respective manufacturer.

Our guarantee refers only to products from our system.

For detailed information and application techniques, please refer to pages 23 and 28 – 29.



10

The surface is now ready for tiling or plastering.



11a

After tiling the TUB-RA... grate fitting frame can be fitted. Measure the distance from the top edge of the laid tile to the lower edge of the ramp frame. Add 10 mm - 3/8" to this value.



12b

Mark this distance all round the grate fitting stub. Cut off the excess part using a bow saw. Insert the fitting stub carefully into the TUB shower base element and check your work.

# LUX ELEMENTS – WETROOM SOLUTION

Secure. Fast. Individual.

## ■ Curbless shower base – Installation in wooden sub-constructions

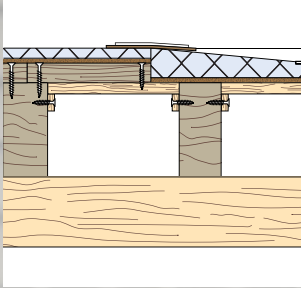

### PREPARATION

Before proceeding, check thoroughly for pipes and wires under the floor. From the nails or screws holding the existing flooring down, establish where the joists are. Paint the entire floor area with wood floor primer.



1a

Mark the LUX ELEMENTS TUB® shower tray position onto the floor. Carefully remove the TUB shower tray and store somewhere safe.



1b

Remove all nails and screws within the marked area. Adjust the cutting depth of the circular saw to the thickness of the existing wooden flooring. Saw along the marked lines using the circular saw ...



1c

... and then remove the floor. Make sure that the remaining floor boards or sheets in the rest of the room are fully secured down and as level and flat as possible.



2a

Measure the spacings between the beams from centre line to centre line.



2b

Mark the centre line of the first joist outside the TUB shower base element. You must remove the floor up to this line. Keep this floor piece!



3a

All exposed joists will now need a batten running along the inside of the joist. Cut some wooden battens to length.



3b

To accommodate the new plywood low level floor, the slats must be attached exactly one plywood board thickness underneath the top edge of the joists.



3c

Screw the slats at approximately 150 mm · 5 7/8" intervals to the inside of all joists.

# Shower bases and drain system – Processing

Installation video on [www.m.luxeelements.com](http://www.m.luxeelements.com)  
or visit our new Youtube-Channel on  
[www.youtube.com/user/luxeelements.com](http://www.youtube.com/user/luxeelements.com)

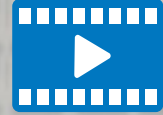

4a

Cut some plywood to fit between the joists on top of the batten fitted in step 3c.



4b

Using a jig saw, saw a hole in the plywood so that the drain and the adaptor can be reached through the new floor.



4c

Fix the plywood on top of the wooden battens with a suitable wood screw at approximately 150 mm · 5 7/8" intervals.



5a

Mark the LUX ELEMENTS TUB® shower tray position onto the new floor. Carefully remove the TUB shower tray and store somewhere safe.



5b

The gap between the edge of the TUB shower tray and the start of the original flooring should be filled with a piece of the flooring that you removed in step 2b and securely screwed down onto the new plywood.



6

Adhesion of the shower base, installation of the standard adaptor and leak tightness test as on pages 24 and 25.



7a

Install ELEMENT-EL Baby construction panels in the appropriate thickness (<math>< 10 \text{ mm} \cdot 3/8 \text{''}</math>) for connection. Select screws according to the substrate and panel thickness using FIX-S 35 fastening washers.



7b

The ELEMENT panels are designed to be fitted flat. Cross joints are not permissible. Screwing according to the indicated intervals.

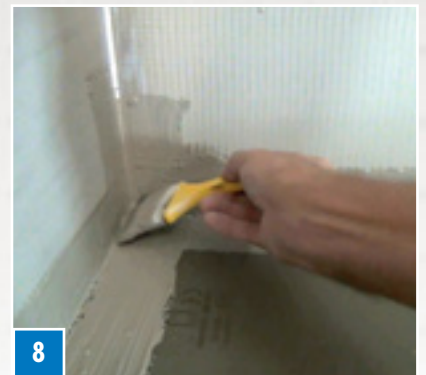

8

Sealing of the shower base and the adjacent walls and floors as on page 25. Sealing of the remaining floor as on page 13 figures 3 – 4b.

# LUX ELEMENTS – WETROOM SOLUTION

Secure. Fast. Individual.

## ■ Sealing of the shower area – with sealing filler and sealing tape

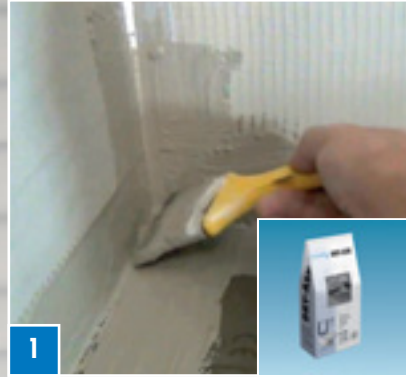
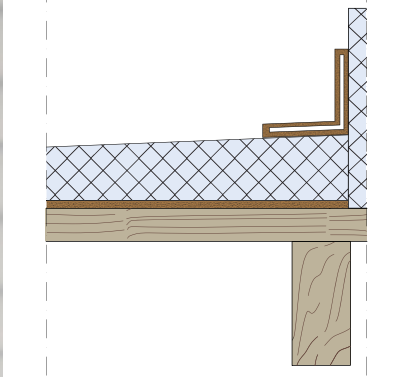

**1** Brush DRY-ASK sealing filler onto the corners and edges to seal the shower base.

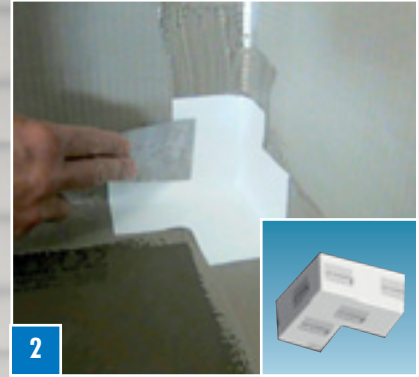

**2** Apply DRY-DB-IE sealing tape as a moulding for the inner corners and press on using a smoothing trowel.



**3** In the second step the joint is levelled out using DRY-ASK sealing filler.

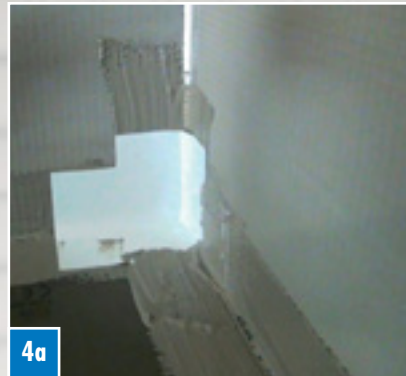

**4a** Using the same method, seal the remaining edges of the shower base and the adjacent walls and floors ...



**4b** ... with DRY-ASK sealing filler and DRY-DB sealing tape.

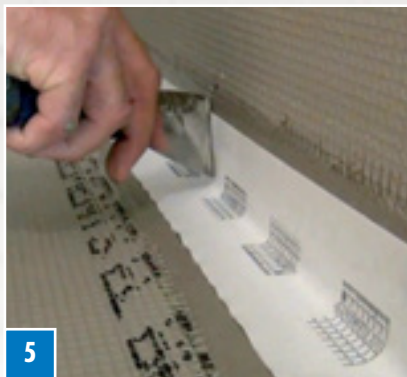

**5** Press the sealing tape on with a smoothing trowel.



**6** Level out the adjacent surfaces and joints using DRY-ASK sealing filler.



**7a** The surface is now ready for tiling or plastering.

# Sealing of the shower area – Processing

Installation video on [www.m.luxelements.com](http://www.m.luxelements.com)  
or visit our new Youtube-Channel on  
[www.youtube.com/user/luxelements.com](http://www.youtube.com/user/luxelements.com)

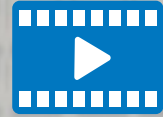

## ■ Sealing of the shower area – with mounting adhesive and sealing tape

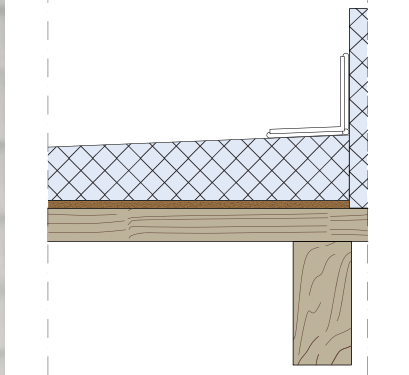

**1** Use a continuous strand of COL-MK mounting adhesive to seal the edges of the shower base.

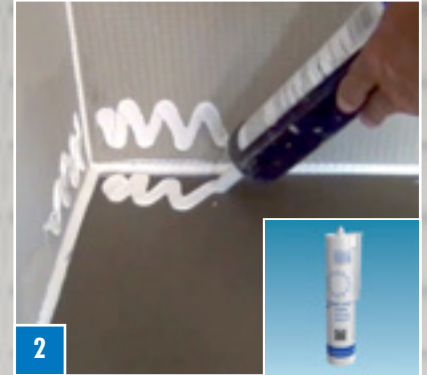

**2** In the corners, additionally apply the adhesive in a serpentine pattern ...



**3** ... and spread it using a notched trowel.

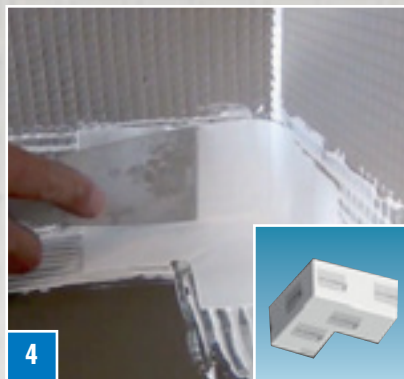

**4** Apply DRY-DB-IE sealing tape as a moulding for the inner corners and press on using a smooth trowel. Remove excess adhesive.



**5** Seal the remaining edges of the shower base and the adjacent walls and floors using COL-MK mounting adhesive ...



**6** ... and DRY-DB sealing tape.



**7** Remove excess adhesive.



**8** The surface is now ready for tiling or plastering.

## Benches

### Specifications



#### ■ Bench seat corner

##### LUX ELEMENTS®-RELAX-BA-CO

bench seat corner, solid

dimensions:  
816 x 577 x 508 mm  
32 1/8" x 22 11/16" x 20"

##### LUX ELEMENTS®-RELAX-BA-CO FLOAT ...

bench seat corner, floating, with assembling kit:

- 1 cartridge mounting adhesive COL-MK
- 6 fastening sets FIX-SB 80S35
- 4 special screw plugs FIX-SD 80

##### RELAX-BA-CO FLOAT L

large, dimensions:  
864 x 610 x 100 mm  
34" x 24" x 3 15/16"

##### RELAX-BA-CO FLOAT S

small, dimensions:  
610 x 430 x 100 mm  
24" x 16 15/16" x 3 15/16"

#### ■ Bench straight

LUX ELEMENTS®-RELAX-BA-SOLO-G ...  
bench form SOLO, straight

##### RELAX-BA-SOLO-G 900

dimensions:  
900 x 500 x 450 mm  
35 7/16" x 19 11/16" x 17 11/16"

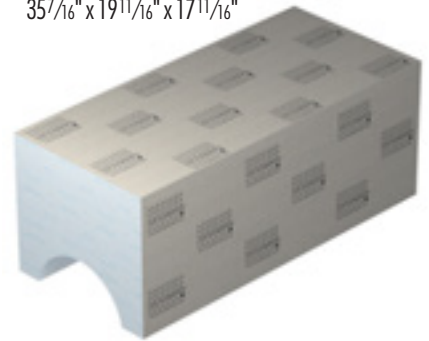

##### RELAX-BA-SOLO-G 750

dimensions:  
750 x 500 x 450 mm  
29 1/2" x 19 11/16" x 17 11/16"

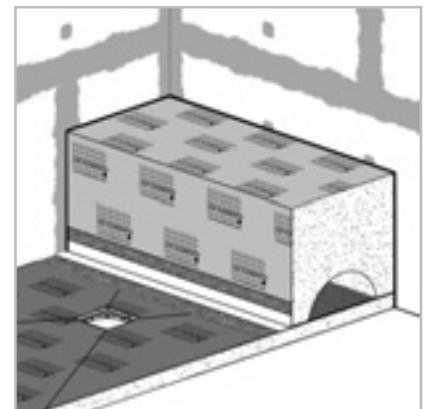
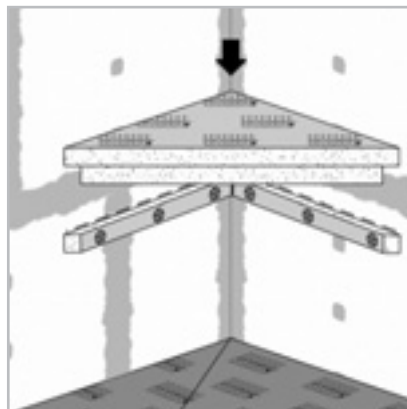
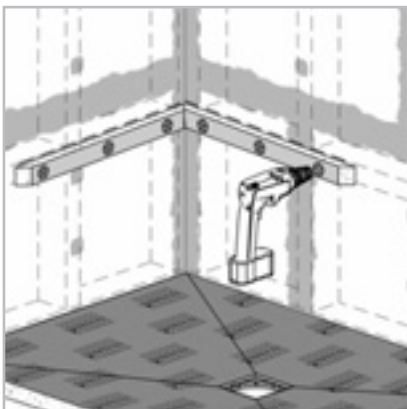
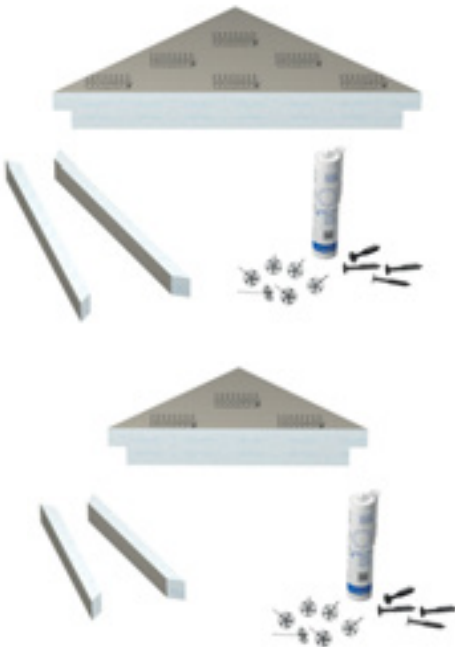
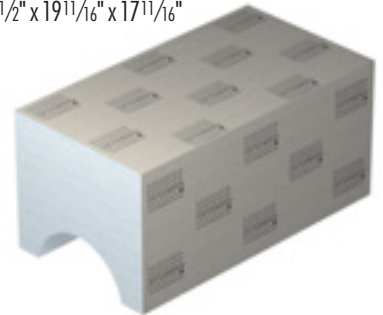

# Niches

## Specifications

### ■ Niches



**LUX ELEMENTS®-RELAX-NI ...**  
prefabricated from ELEMENT-EL 12



**RELAX-NI-S**  
external dimensions: 406 x 89 x 203 mm  
16" x 3 1/2" x 8"  
internal dimensions: 305 x 77 x 102 mm  
11" x 3" x 4"



**RELAX-NI-M**  
external dimensions: 406 x 89 x 406 mm  
16" x 3 1/2" x 16"  
internal dimensions: 305 x 77 x 304 mm  
11" x 3" x 11"



**RELAX-NI-L**  
with one shelf  
external dimensions: 406 x 89 x 559 mm  
16" x 3 1/2" x 22"  
internal dimensions: 305 x 77 x 457 mm  
11" x 3" x 18"

**RELAX-NI-XL**  
with two shelves  
external dimensions: 406 x 89 x 1070 mm  
16" x 3 1/2" x 42 1/8"  
internal dimensions: 305 x 77 x 968 mm  
11" x 3" x 38"

### ■ Additional material required:

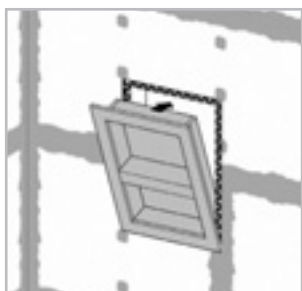

# Curbs and Ramps

## Specifications

### ■ Curbs

Prefabricated curbs made of hard foam support material

**LUX ELEMENTS®-RELAX-CU-F 5**

dimensions:  
1524 x 114 x 130/127 mm  
60" x 4 1/2" x 5 1/8"/5"



**LUX ELEMENTS®-RELAX-RP M**  
medium, gradient 19,2%, dimensions:  
1828 x 204 x 45 mm  
71 15/16" x 8 1/16" x 1 3/4"

### ■ Ramps

Prefabricated ramps made of hard foam support material

**LUX ELEMENTS®-RELAX-RP M**

gradient 19,2%, external dimensions:  
1828 x 204 x 45 mm  
71 15/16" x 8 1/16" x 1 3/4"

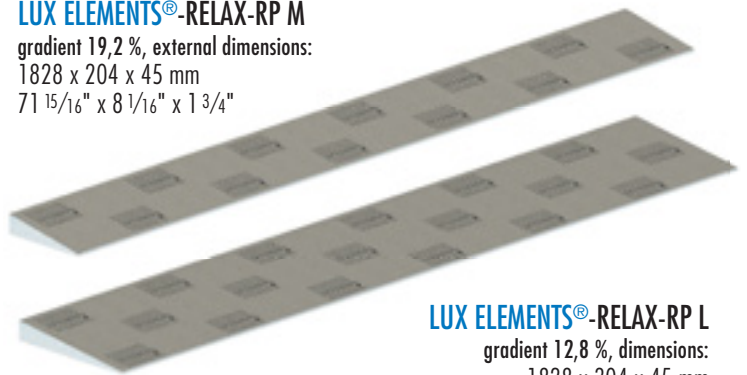

**LUX ELEMENTS®-RELAX-RP L**  
gradient 12,8%, dimensions:  
1828 x 304 x 45 mm  
71 15/16" x 11 15/16" x 1 3/4"

### ■ Additional material required:

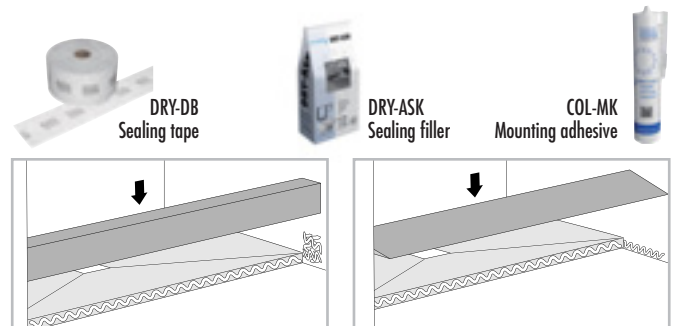

# LUX ELEMENTS – WETROOM SOLUTION

Secure. Fast. Individual.

## ■ Bench seat corner – floating

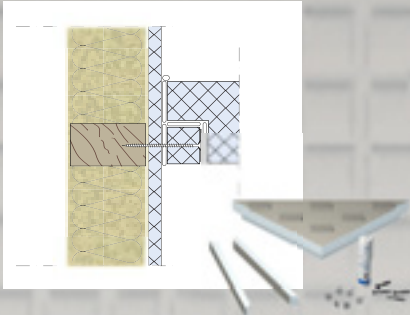

### PREPARATION

Please observe that the stop plates on which the seat is fixed can be anchored in the stud frame.

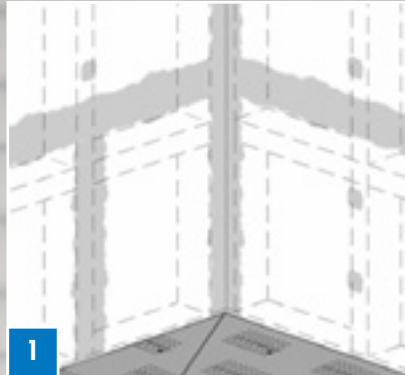

1

For new buildings, plan the stud frame in such a way that a cross beam is installed at the point bearing the load. For renovation work, insert the necessary braces.



2a

Measure the desired sitting height ...

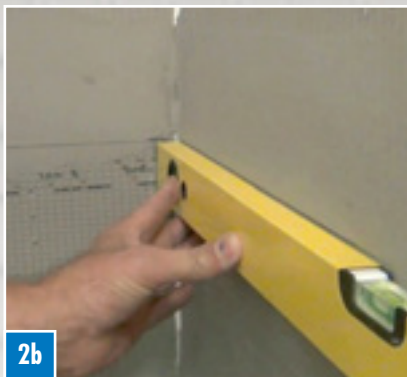

2b

... and mark it in vertical alignment.

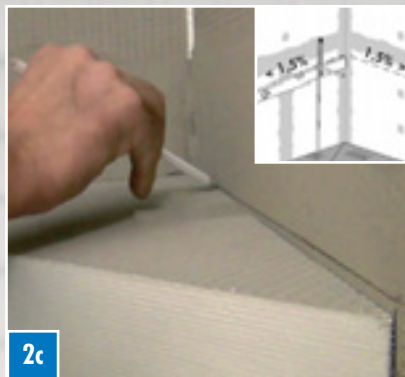

2c

The seat requires a slope to drain off splash water.

For this purpose, position the seat, move it downwards by at least 1.5 % in the front area and then mark it.

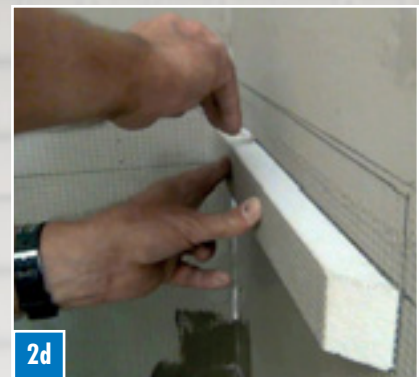

2d

Apply and mark the wall fittings on this new line.

Remove all nails and screws within the marked area.



3

Then apply COL-MK mounting adhesive to the rear side of the wall fittings in a serpentine pattern and move them slightly against one another when bonding the contact surfaces.

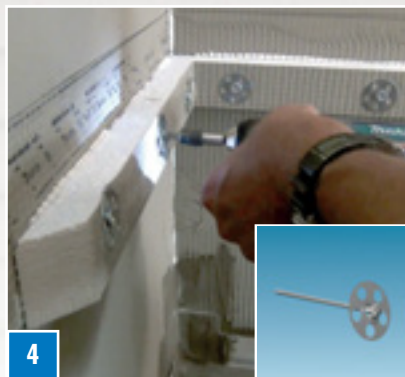

4

Screw down the stop plates using a suitable FIX-SB fastening set.



5a

Apply COL-MK mounting adhesive in a serpentine pattern to all edges to be bonded, ...



# Benches – Processing

Installation video on [www.luxelements.com](http://www.luxelements.com)  
or visit our new Youtube-Channel on  
[www.youtube.com/user/luxelements.com](http://www.youtube.com/user/luxelements.com)

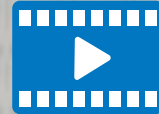

5b

... position the seat surface on the wall fittings and move the adhesive surfaces slightly against one another while doing so. Then press on firmly.



6a

TIP: Pre-pierce dowel holes using a cross slot screwdriver.

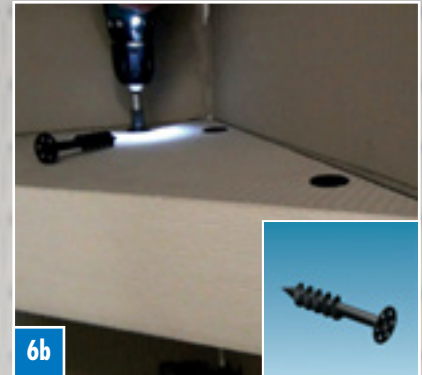

6b

Screw the seat surface to the stop plates using 2 screw plugs of type FIX-SD-80.



6c

Check the slope of the seating face with a spirit level.

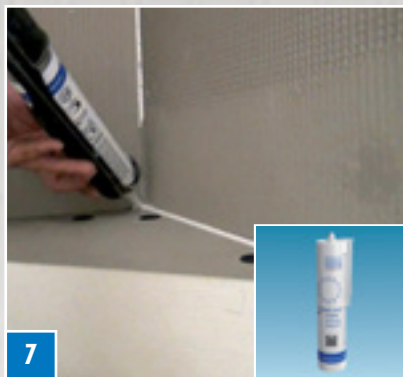

7

Finally, apply a continuous strand of COL-MK mounting adhesive to the abutting edges.

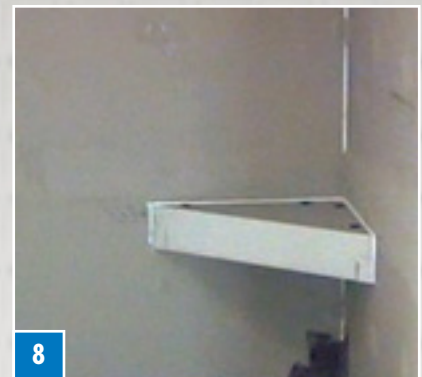

8

The surface is now ready for tiling or plastering.

Would you like detailed information about a product, or are you looking for a data sheet, a test certificate or installation instructions? You will find all product information and a comprehensive download area on our homepage. Simply click and take a look. [www.luxelements.com](http://www.luxelements.com)

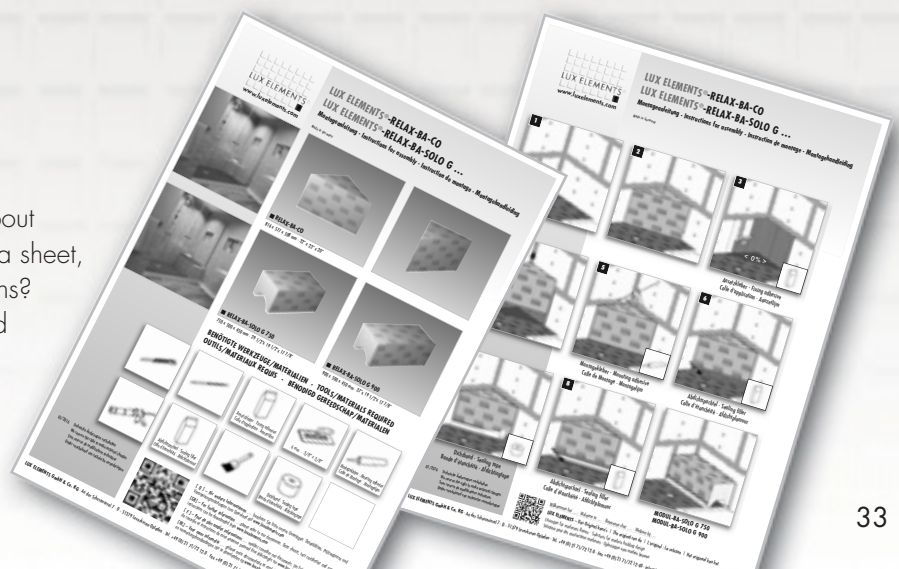

# LUX ELEMENTS – WETROOM SOLUTION

Secure. Fast. Individual.

## ■ Niche – with two shelves

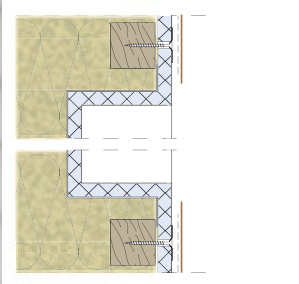

### PREPARATION

Make sure that the outer edging of the niche can be anchored in the stud frame. For this, the outer edge of the niche must lie centrally on the beam.

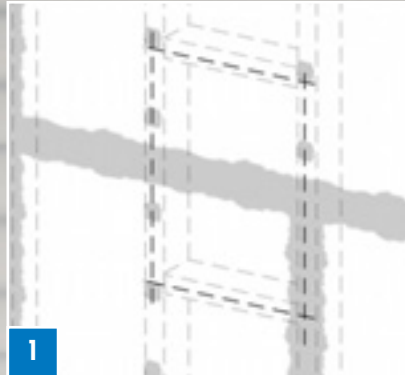

1

In new buildings, plan the spacing of the stud frame accordingly and install cross beams at the positions required. For renovation work, insert the necessary braces.



2

Mark the desired position of the niche in vertical alignment. Remove all nails and screws within the marked area.



3a

Use a cutter to cut the outer contours of the niche out of the boarding.



3b

This can then be easily lifted out of the remaining wall using a spatula.

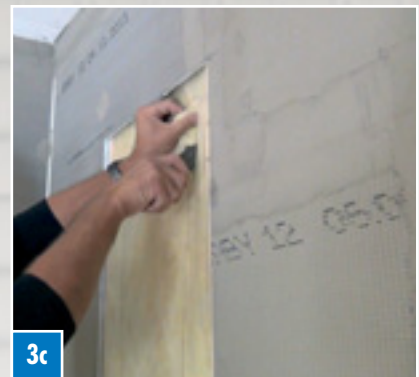

3c

If necessary, remove the insulating material for the depth of the niche.

**Important:** Subsequently, close the air tightness layer (film) again.

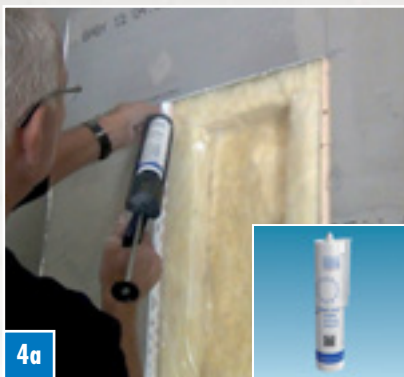

4a

Apply COL-MK mounting adhesive in a serpentine pattern to all edges to be bonded, ...

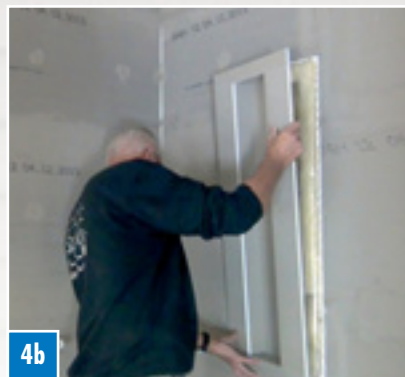

4b

... insert the niche into the wall and move the adhesive surface slightly against one another while doing so. Then press on firmly.

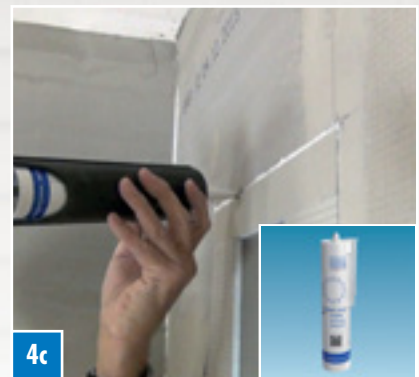

4c

Once again, apply a continuous strand of COL-MK mounting adhesive to the seam edges.

# Niches – Processing

Installation video on [www.m.luxelements.com](http://www.m.luxelements.com)  
or visit our new Youtube-Channel on  
[www.youtube.com/user/luxelements.com](http://www.youtube.com/user/luxelements.com)

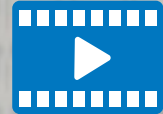

4d

Remove excess adhesive.

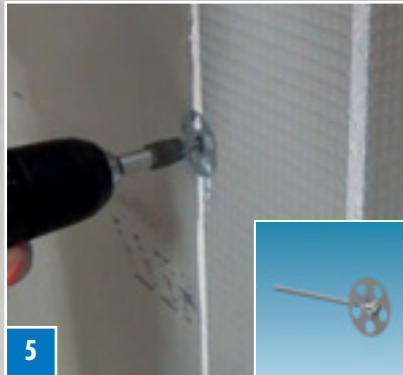

5

Screw down the seam edges using a suitable FIX-SB fastening set.

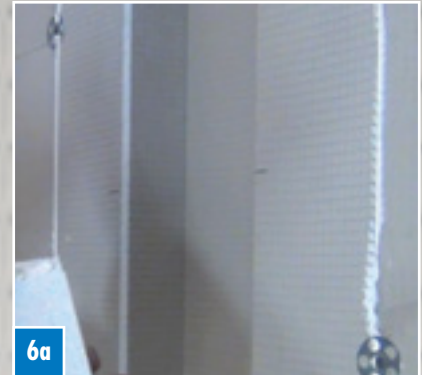

6a

Mark the position of the niche bases.



6b

Apply COL-MK mounting adhesive in a serpentine pattern to the base edges to be bonded, ...



6c

... insert the base into the niche and move the adhesive surfaces slightly against one another while doing so.

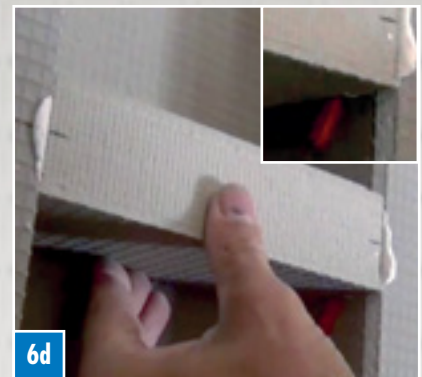

6d

Bring the niche base into position and secure it until the adhesive has set. Remove excess adhesive.

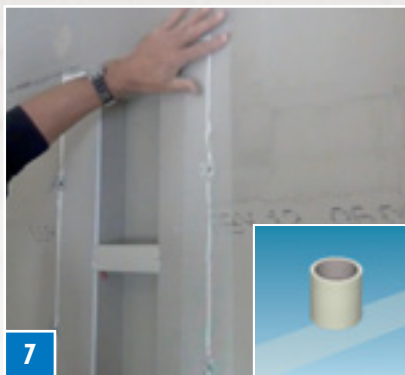

7

All element joints must be reinforced with glass fibre reinforcement strips ARM-100 SK.



8

Level out the reinforced element joints and the heads of the mounting elements with fixing adhesive.



9

The surface is now ready for tiling or plastering.

# LUX ELEMENTS – WETROOM SOLUTION

Secure. Fast. Individual.

## ■ Curb or ramp

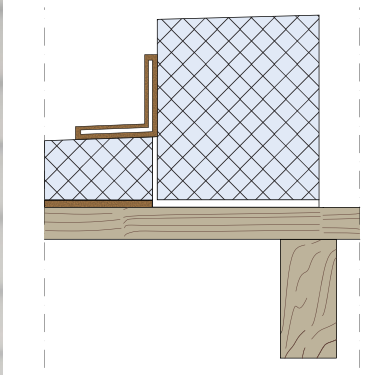

**1a**

Transfer the desired length to the curb ...



**1b**

... and cut it to size.



**1c**

Check the measurement accuracy prior to bonding.



**1d**

Apply COL-MK mounting adhesive in a serpentine pattern to all edges to be bonded, ...



**2a**

... insert the curb and move the adhesive surfaces slightly against one another while doing so. Then press on firmly.

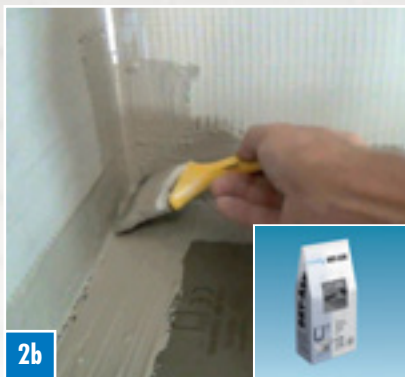

**2b**

Seal the inner side of the curb just as the rest of the shower base, using tape DRY-ASK sealing filler...



**2c**

... and DRY-DB sealing tape. See page 26.

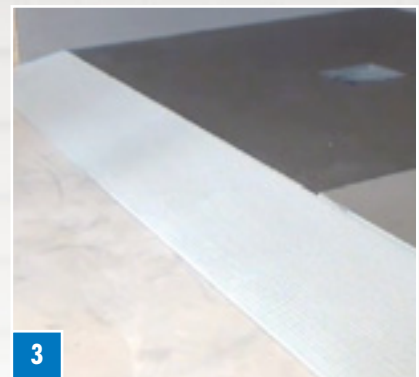

**3**

Assembly of the ramp is performed according to the same principle.

# Curbs and Ramps – Processing

Installation video on [www.luxelements.com](http://www.luxelements.com)  
or visit our new Youtube-Channel on  
[www.youtube.com/user/luxelements.com](http://www.youtube.com/user/luxelements.com)

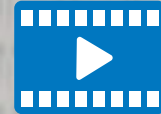

**LUX ELEMENTS®-RELAX-CU-F ...**

Montageanleitung - Instructions for assembly - Instruction de montage - Montagehandleiding

■ RELAX-CU-F 5  
320 x 114 x 10 mm

■ RELAX-CU-F 6  
304 x 114 x 10 mm

**BENÖTIGTE WERKZEUGE/MATERIALIEN - TOOLS/MATERIALS REQUIRED  
OUTILS/MATERIAUX REQUIS - BENODIGD GEREEDSCHAP/MATERIALEN**

111001: Nachbaukategorie: verboten  
111002: Nachbaukategorie: verboten  
111003: Nachbaukategorie: verboten  
111004: Nachbaukategorie: verboten  
111005: Nachbaukategorie: verboten  
111006: Nachbaukategorie: verboten  
111007: Nachbaukategorie: verboten  
111008: Nachbaukategorie: verboten  
111009: Nachbaukategorie: verboten  
111010: Nachbaukategorie: verboten  
111011: Nachbaukategorie: verboten  
111012: Nachbaukategorie: verboten  
111013: Nachbaukategorie: verboten  
111014: Nachbaukategorie: verboten  
111015: Nachbaukategorie: verboten  
111016: Nachbaukategorie: verboten  
111017: Nachbaukategorie: verboten  
111018: Nachbaukategorie: verboten  
111019: Nachbaukategorie: verboten  
111020: Nachbaukategorie: verboten

LUX ELEMENTS GmbH & Co. KG, In der Schenkerstr. 7, D-52377 Lorchstein-Opfeln, Tel. +49 (0) 221 71 02 12-0, Fax +49 (0) 221 71 02 12-140, info@luxelements.de, www.luxelements.com

**LUX ELEMENTS®-RELAX-CU-F ...**

Montageanleitung - Instructions for assembly - Instruction de montage - Montagehandleiding

111001: Nachbaukategorie: verboten  
111002: Nachbaukategorie: verboten  
111003: Nachbaukategorie: verboten  
111004: Nachbaukategorie: verboten  
111005: Nachbaukategorie: verboten  
111006: Nachbaukategorie: verboten  
111007: Nachbaukategorie: verboten  
111008: Nachbaukategorie: verboten  
111009: Nachbaukategorie: verboten  
111010: Nachbaukategorie: verboten  
111011: Nachbaukategorie: verboten  
111012: Nachbaukategorie: verboten  
111013: Nachbaukategorie: verboten  
111014: Nachbaukategorie: verboten  
111015: Nachbaukategorie: verboten  
111016: Nachbaukategorie: verboten  
111017: Nachbaukategorie: verboten  
111018: Nachbaukategorie: verboten  
111019: Nachbaukategorie: verboten  
111020: Nachbaukategorie: verboten

LUX ELEMENTS GmbH & Co. KG, In der Schenkerstr. 7, D-52377 Lorchstein-Opfeln, Tel. +49 (0) 221 71 02 12-0, Fax +49 (0) 221 71 02 12-140, info@luxelements.de, www.luxelements.com



**LUX ELEMENTS®-RELAX-RP ...**

Montageanleitung - Instructions for assembly - Instruction de montage - Montagehandleiding

■ RELAX-RP M  
301 x 108 x 41 x 6 mm

■ RELAX-RP L  
30 x 108 x 41 x 6 mm

**BENÖTIGTE WERKZEUGE/MATERIALIEN - TOOLS/MATERIALS REQUIRED  
OUTILS/MATERIAUX REQUIS - BENODIGD GEREEDSCHAP/MATERIALEN**

111001: Nachbaukategorie: verboten  
111002: Nachbaukategorie: verboten  
111003: Nachbaukategorie: verboten  
111004: Nachbaukategorie: verboten  
111005: Nachbaukategorie: verboten  
111006: Nachbaukategorie: verboten  
111007: Nachbaukategorie: verboten  
111008: Nachbaukategorie: verboten  
111009: Nachbaukategorie: verboten  
111010: Nachbaukategorie: verboten  
111011: Nachbaukategorie: verboten  
111012: Nachbaukategorie: verboten  
111013: Nachbaukategorie: verboten  
111014: Nachbaukategorie: verboten  
111015: Nachbaukategorie: verboten  
111016: Nachbaukategorie: verboten  
111017: Nachbaukategorie: verboten  
111018: Nachbaukategorie: verboten  
111019: Nachbaukategorie: verboten  
111020: Nachbaukategorie: verboten

LUX ELEMENTS GmbH & Co. KG, In der Schenkerstr. 7, D-52377 Lorchstein-Opfeln, Tel. +49 (0) 221 71 02 12-0, Fax +49 (0) 221 71 02 12-140, info@luxelements.de, www.luxelements.com

**LUX ELEMENTS®-RELAX-RP ...**

Montageanleitung - Instructions for assembly - Instruction de montage - Montagehandleiding

111001: Nachbaukategorie: verboten  
111002: Nachbaukategorie: verboten  
111003: Nachbaukategorie: verboten  
111004: Nachbaukategorie: verboten  
111005: Nachbaukategorie: verboten  
111006: Nachbaukategorie: verboten  
111007: Nachbaukategorie: verboten  
111008: Nachbaukategorie: verboten  
111009: Nachbaukategorie: verboten  
111010: Nachbaukategorie: verboten  
111011: Nachbaukategorie: verboten  
111012: Nachbaukategorie: verboten  
111013: Nachbaukategorie: verboten  
111014: Nachbaukategorie: verboten  
111015: Nachbaukategorie: verboten  
111016: Nachbaukategorie: verboten  
111017: Nachbaukategorie: verboten  
111018: Nachbaukategorie: verboten  
111019: Nachbaukategorie: verboten  
111020: Nachbaukategorie: verboten

LUX ELEMENTS GmbH & Co. KG, In der Schenkerstr. 7, D-52377 Lorchstein-Opfeln, Tel. +49 (0) 221 71 02 12-0, Fax +49 (0) 221 71 02 12-140, info@luxelements.de, www.luxelements.com



Would you like detailed information about a product, or are you looking for a data sheet, a test certificate or installation instructions? You will find all product information and a comprehensive download area on our homepage. Simply click and take a look.

**[www.luxelements.ca](http://www.luxelements.ca)**



## Washstands

### Specifications

#### ■ LUX ELEMENTS®-LAVADO-FLOAT – the principle

Hard foam support element  
with fabric coating

Basin recess  
with built-in slope

Conventional stem valves e.g. Viega Visign V1  
are suitable for the drain connection

Assembly openings  
for the simple assembly of drain and taps

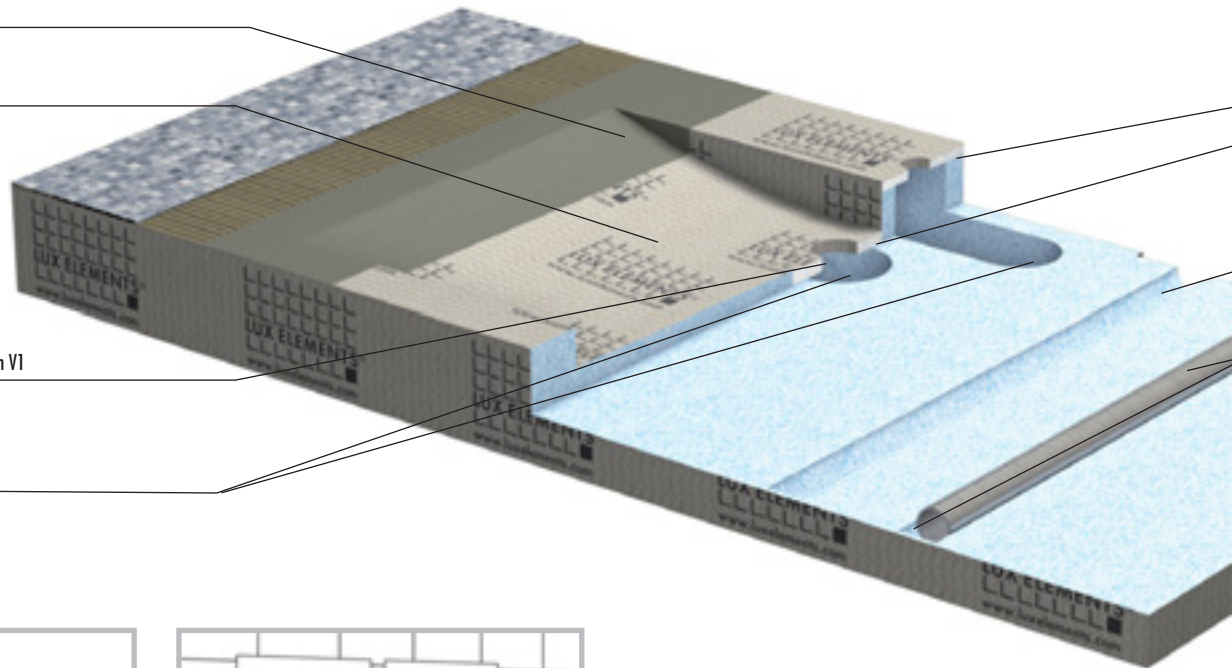

Simple to shorten

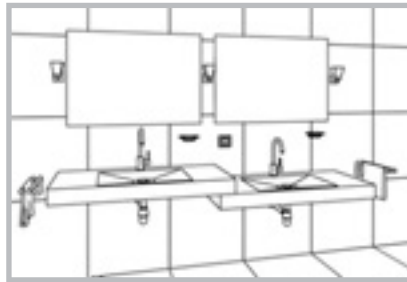
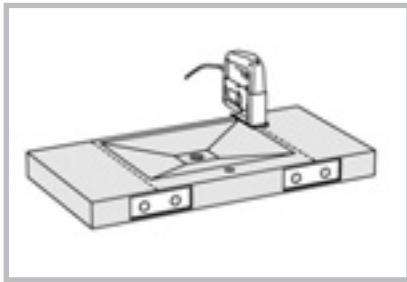

The construction of a row of washstands is also possible by means of **arranging and glueing together** several washstands

The installation of LAVADO-FLOAT is possible not only on masonry but also on stud frames

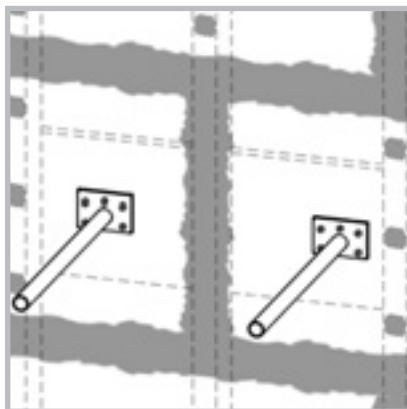
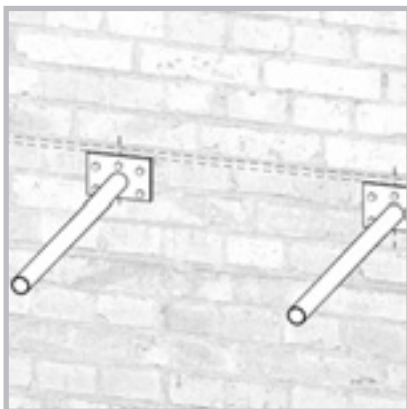

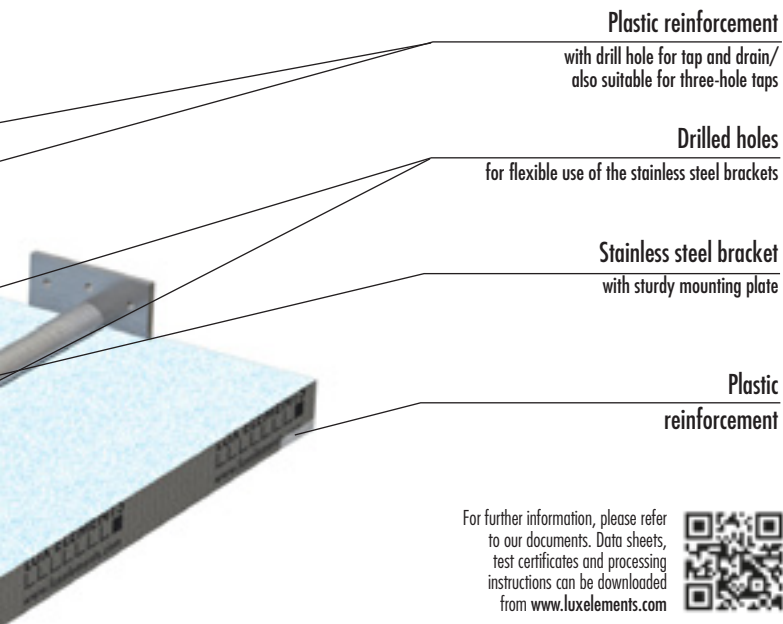

**Plastic reinforcement**

with drill hole for tap and drain/  
also suitable for three-hole taps

**Drilled holes**

for flexible use of the stainless steel brackets

**Stainless steel bracket**

with sturdy mounting plate

**Plastic reinforcement**

For further information, please refer to our documents. Data sheets, test certificates and processing instructions can be downloaded from [www.luxelements.com](http://www.luxelements.com)



### Additional material required:

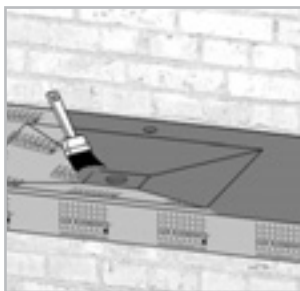

DRY-ASK  
Sealing filler



suitable screw

## LAVADO-FLOAT

Washstands with invisible suspension as set for single washing facility, incl. 1 piece COL-MK and 2 stainless steel brackets 450 mm · 17<sup>11/16</sup>" in length.

### LUX ELEMENTS®-LAVADO-FLOAT G

washstand, even, without recess

dimensions:  
1170 x 585 x 100 mm  
46<sup>1/16</sup>" x 23<sup>1/16</sup>" x 3<sup>15/16</sup>"

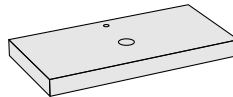
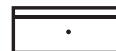

### LUX ELEMENTS®-LAVADO-FLOAT E

washstand with elliptical recess

dimensions:  
1170 x 585 x 100 mm  
46<sup>1/16</sup>" x 23<sup>1/16</sup>" x 3<sup>15/16</sup>"

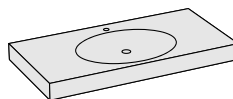

### LUX ELEMENTS®-LAVADO-FLOAT R

washstand with rectangular recess

dimensions:  
1170 x 585 x 100 mm  
46<sup>1/16</sup>" x 23<sup>1/16</sup>" x 3<sup>15/16</sup>"

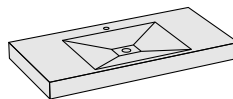

### LUX ELEMENTS®-LAVADO-FLOAT Z

washstand with cylindrical recess

dimensions:  
1170 x 585 x 100 mm  
46<sup>1/16</sup>" x 23<sup>1/16</sup>" x 3<sup>15/16</sup>"

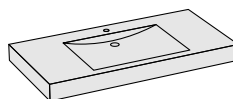

# LUX ELEMENTS – WETROOM SOLUTION

Secure. Fast. Individual.

## ■ Washstands – e.g. LAVADO-FLOAT Z

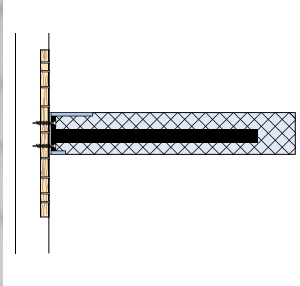

### PREPARATION

When assembling on a stud frame: Please observe that the stainless steel brackets that carry the washstand body can be anchored in the stud frame.



1a

Take the washstand out of its packaging and remove the stainless steel brackets. Keep the individual parts in a safe place until they are installed.



1b

Observe the enclosed installation instructions. Take the notes for wall construction into account.

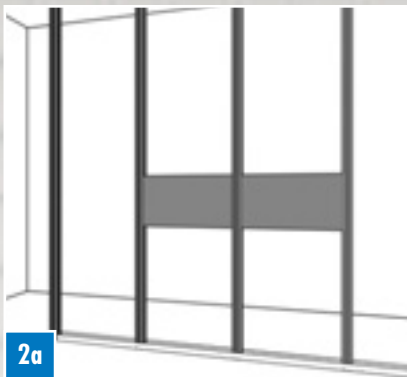

2a

Install a mounting plate with a sufficient loadbearing capacity crossbeam ( $d > 18 \text{ mm} \cdot d > 1\frac{1}{16}''$ ) for fastening the LUX ELEMENTS® LAVADO-FLOAT ... washstand.

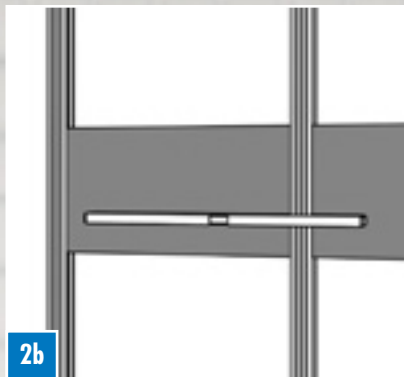

2b

Check the flatness of the construction.



2c

Line the stud wall construction e.g. with LUX ELEMENTS®-ELEMENT-EL. Application instructions on page 12. An alternative cladding is possible.

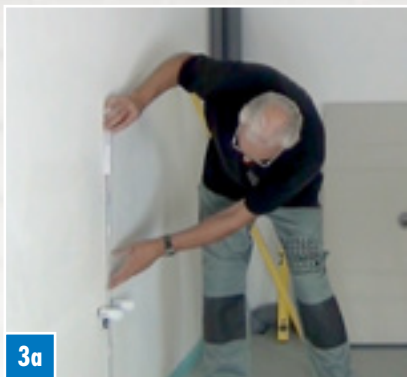

3a

Determine the height of the washstand and mark it in vertical alignment.



3b

Cut out the mounting template on the rear side of the box ...

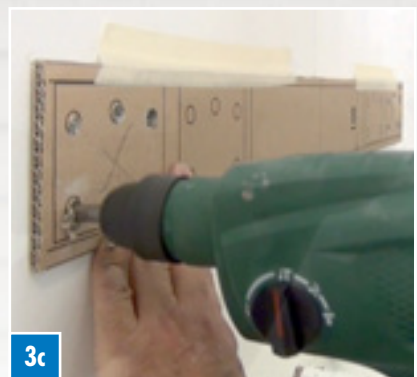

3c

... fasten it vertically to the wall and drill the holes according to the hole pattern.



# Washstands – Processing

Installation video on [www.m.luxelements.com](http://www.m.luxelements.com)  
or visit our new Youtube-Channel on  
[www.youtube.com/user/luxelements.com](http://www.youtube.com/user/luxelements.com)

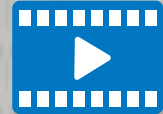

3d

Screws are illustrated as an example

suitable screw

Use screws suitable for the fastening substrate and according to requirements in order to ensure a permanent and stable connection. Screw the brackets flat to the substructure.



4a

Check perpendicularity to the substrate. Ensure that the bracket runs parallel. If in doubt, rework the substrate.

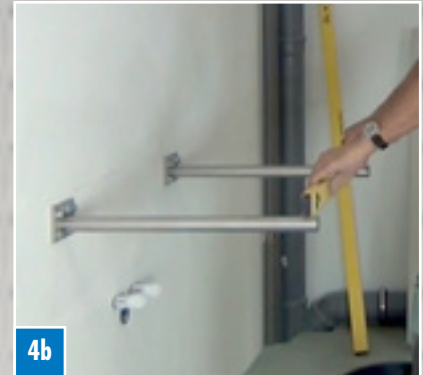

4b

Check and ensure the horizontal seating of the brackets.



5a

Push the washstand onto the brackets without glue in order to check the seating and position.



5b

Apply COL-MK mounting adhesive to all wall-contact surfaces of the washstand. The brackets do not have to be adhered.



5c

Push the washstand onto the brackets ...



5d

... and check the seating and position immediately after assembly. If necessary, readjust before the adhesive hardens.

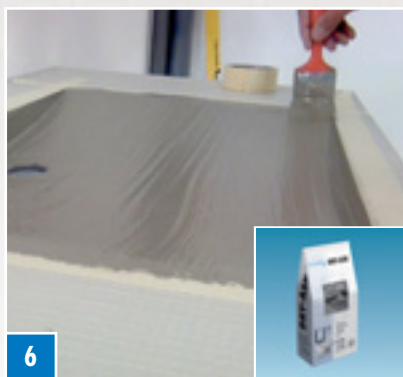

6

Seal the washstand around the washbasin with DRY-ASK sealing filler.



7

The surface is now ready for tiling or plastering.

### Processing tips

#### ■ Storage and transport



All hard foam support elements must be stored lying down straight in a dry place. Should a construction panel be slightly warped due to improper storage or other reasons, it can usually be straightened by light bending and pressing.

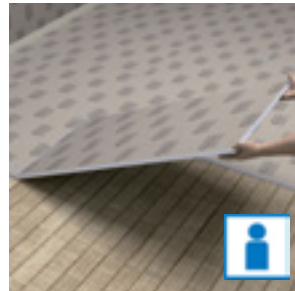

The ELEMENT "Baby" panel can be carried and handled by one person without assistance due to its small size. The so-called "One-man-panel" offers decisive advantages to those working with it:

- easy transport, even in confined spaces e.g. stairs
- fits into smaller vans and other vehicles without being cut to size
- more comfortable installation in small rooms or in attics due to its handy size
- well suited for floor applications

#### ■ Laying and screwing

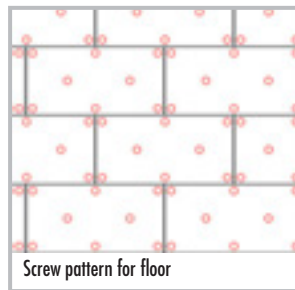
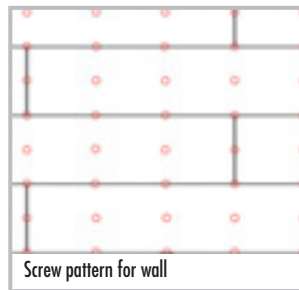
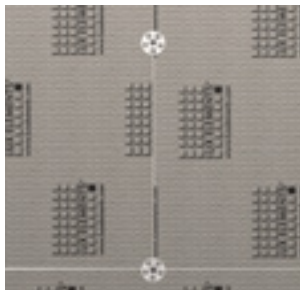

The ELEMENT construction panels are laid in groups; diagonal joints are not allowed.

#### ■ Fixing and glueing

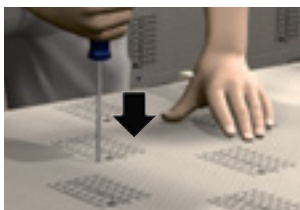

Before applying the adhesive in dots, pre-pierce the holes for the dowels with a cross slot screwdriver.



If ELEMENT-EL Baby 4 is used, **always** apply the fixing adhesive over the full surface using a toothed trowel.



Press the shower base firmly into the thinset bed, ensuring that the installation is level and void free. Apply some weight equally and for at least 30 minutes.

#### ■ Optimal edge glueing

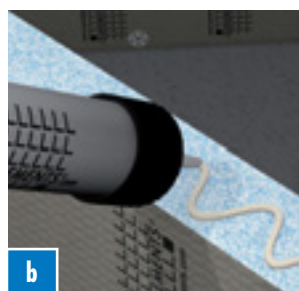

If an absolutely even glueing surface is required, the edges of the hard foam support element should first be ground. For this, use an emery board.

Hard foam support elements are glued to one another using COL-MK. The adhesive is applied in a serpentine pattern to the edges of the panels.

To achieve optimal adhesive distribution, the construction panels are rubbed against one another slightly when placed together.

## ■ Easy fastening – for light loads on tiles

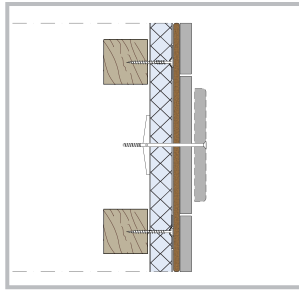

e.g. for a combination stud frame/tile  
Drilling the tile for the use of a suitable cavity dowel.

## ■ Easy fastening – for light loads on mosaic

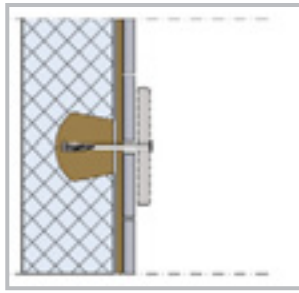

e.g. for a combination of  
full material/mosaic  
Cut the hard foam support material with a cutter, scratch out the hard foam, fill with fixing adhesive, anchor the mounting set later in fixing adhesive.

## ■ Fastenings – for higher load accommodation

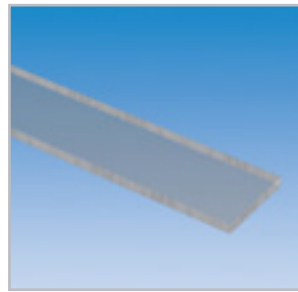
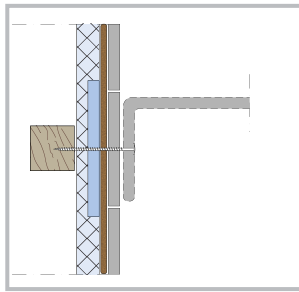

e.g. combination of solid material  
with FIX-PRO-MAK  
Hard plastic insert, which is glued onto the hard foam or embedded into it.

## ■ Installation of wall sockets, cable and pipe installation

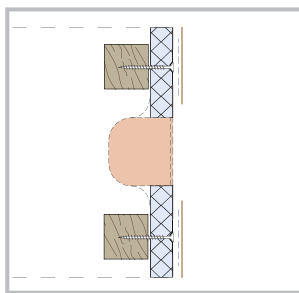

e.g. cavity socket  
in support construction  
Drill a hole in the ELEMENT with a core drill.

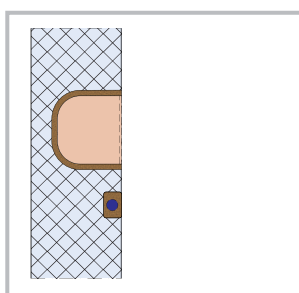

e.g. cavity socket (or lead)  
in solid material  
Cut in parallel into the hard foam support material. Depending on the size and length of the hard foam support elements, cutters or angle grinders (Flex) with a diamondwheel can be used for slitting: Remove hard foam with suitable tools (e.g. screwdriver or wire brush) as far as necessary, lay and level out with fixing adhesive.



LLLLLLLLLL  
LLLLLLLLLL  
LLLLLLLLLL  
**LUX ELEMENTS®**  
LLLLLLLLLL

[www.luxelements.ca](http://www.luxelements.ca)



(D)

**LUX ELEMENTS GmbH & Co. KG**  
An der Schusterinsel 7 · D - 51379 Leverkusen  
Tel. +49 (0) 21 71/7212-0  
Fax +49 (0) 21 71/7212-10  
E-Mail [info@luxelements.de](mailto:info@luxelements.de)  
Web [www.luxelements.com](http://www.luxelements.com)

(F)

**LUX ELEMENTS S.A.S**  
31, rue d'Ensisheim · F - 68190 Ungersheim  
Tél. +33 (0) 3 89 83 69 79  
Fax +33 (0) 3 89 48 83 27  
E-Mail [info@luxelements.fr](mailto:info@luxelements.fr)  
Web [www.luxelements.fr](http://www.luxelements.fr)

Installation videos on [www.m.luxelements.com](http://www.m.luxelements.com) or visit our  
new YouTube-Channel on [www.youtube.com/user/luxelementscom](http://www.youtube.com/user/luxelementscom)

